

INSTALLATION DETAILS (Recommendations only)

Concrete footings, 25mPa:

- Two 300x300x300mm minimum footing size
- Bolt to footings with 12x M12x75mm Dynabolts or similar or

Concrete slab, 25mPa:

- BR7021-3: One 1450x550x100mm (minimum) thick slab
- BR7021-4: One 1950x550x100mm (minimum) thick slab
- BR7021-5: One 2450x550x100mm (minimum) thick slab

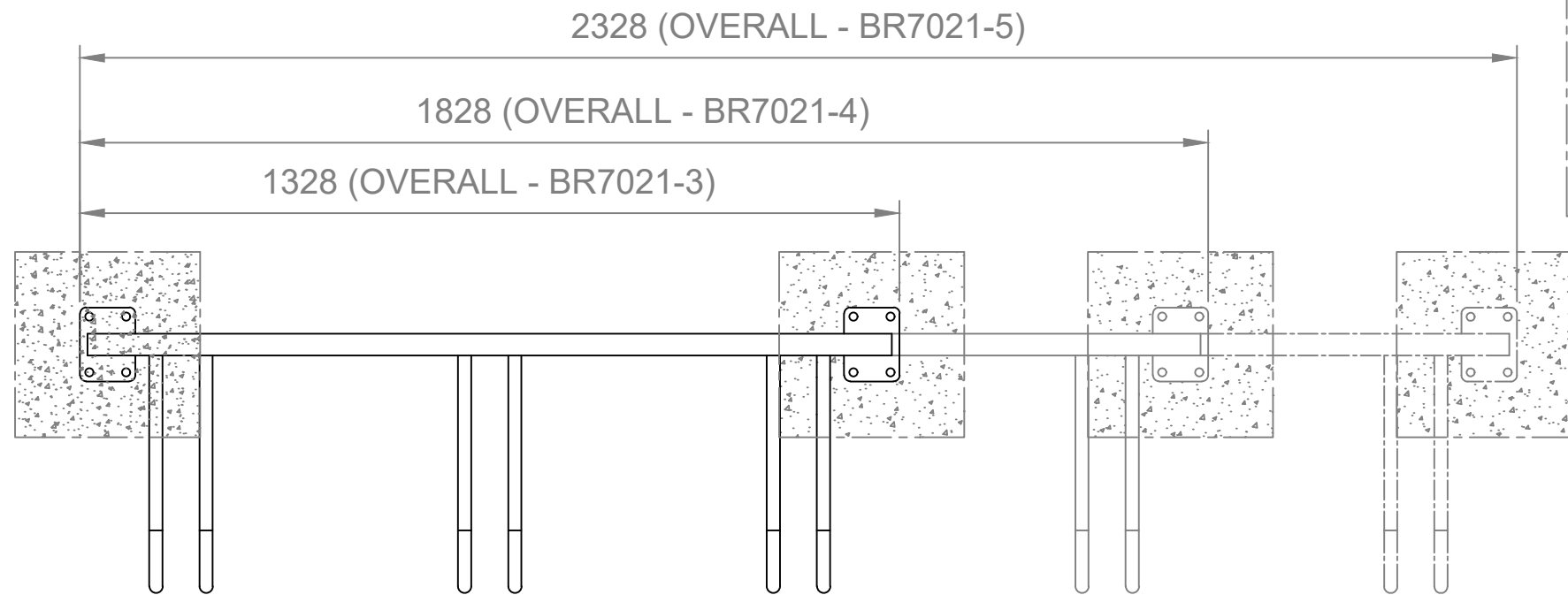

Top view

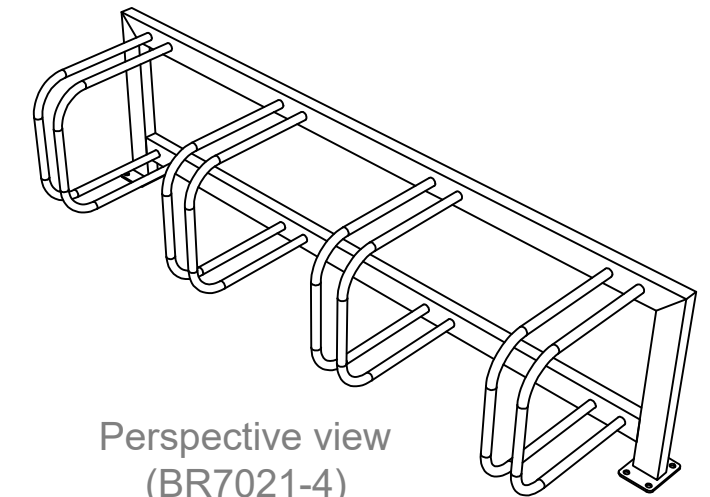

Perspective view (BR7021-4)

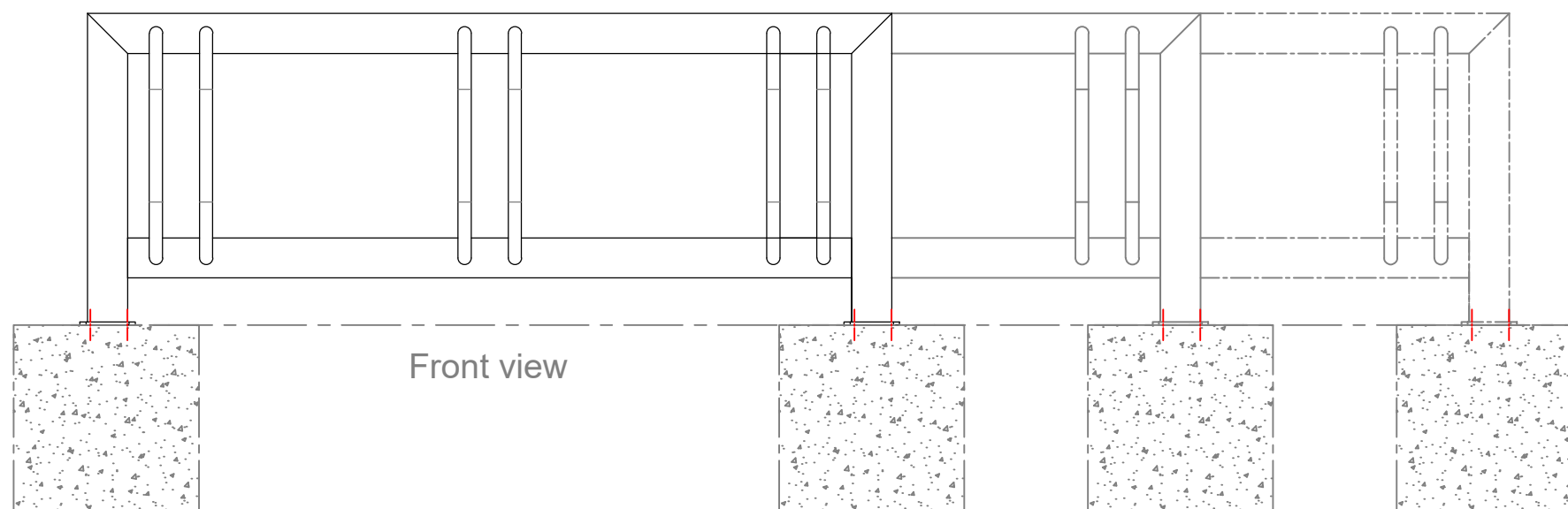

Front view

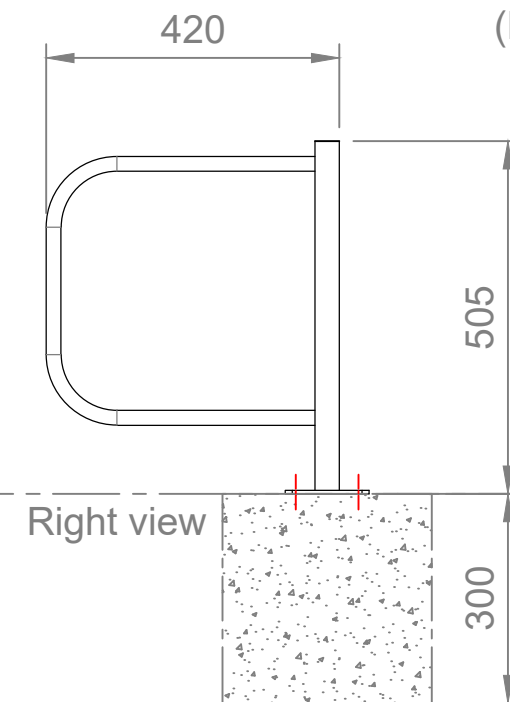

Right view

Ground level

CSA
 Commercial Systems Australia Pty. Ltd.
 42 Orchard St, Kilsyth South, VIC
 phone: (03) 9723 4111
 fax: (03) 9723 3494
 email: design@commercialsystems.com.au

Model Code: BR7021-3, -4, -5
 Model Description: Multi Bike Rack

Drawing: CS0345
 Sheet Number: -
 Sheet Description: Installation

Drawn By: G.Smith
 Date Drawn: 29.07.2011
 Revision Number: 3

SCALE 1:1

ALL DIMENSIONS IN MILLIMETERS
 UNLESS OTHERWISE STATED
 ALL PARTS CENTRED UNLESS SPECIFIED

TOLERANCES
 X +/- 1mm
 X.X +/- 0.5mm
 X.XX +/- 0.05mm

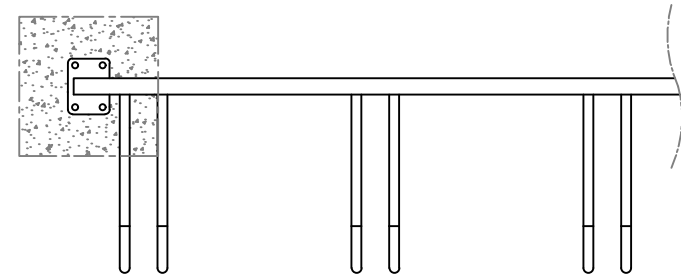

Top view

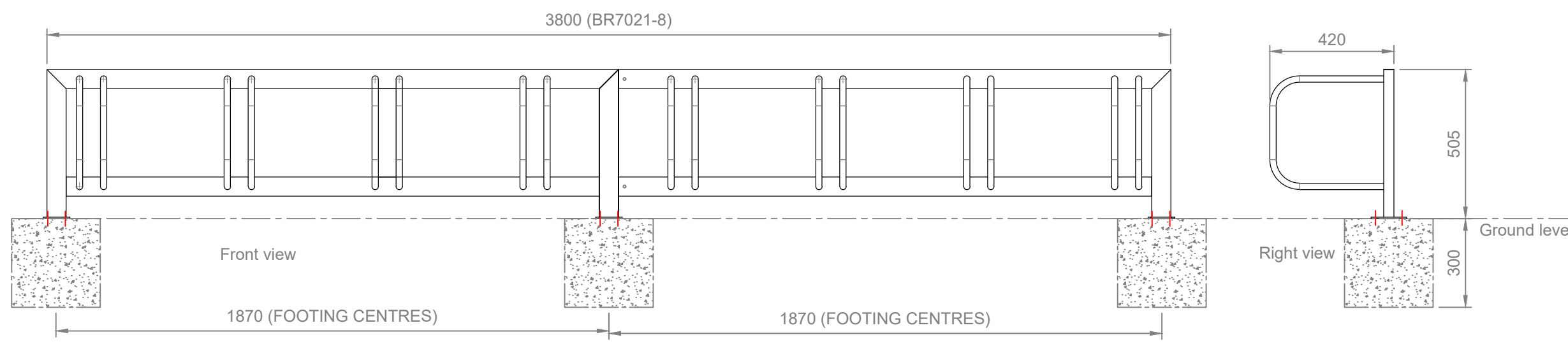
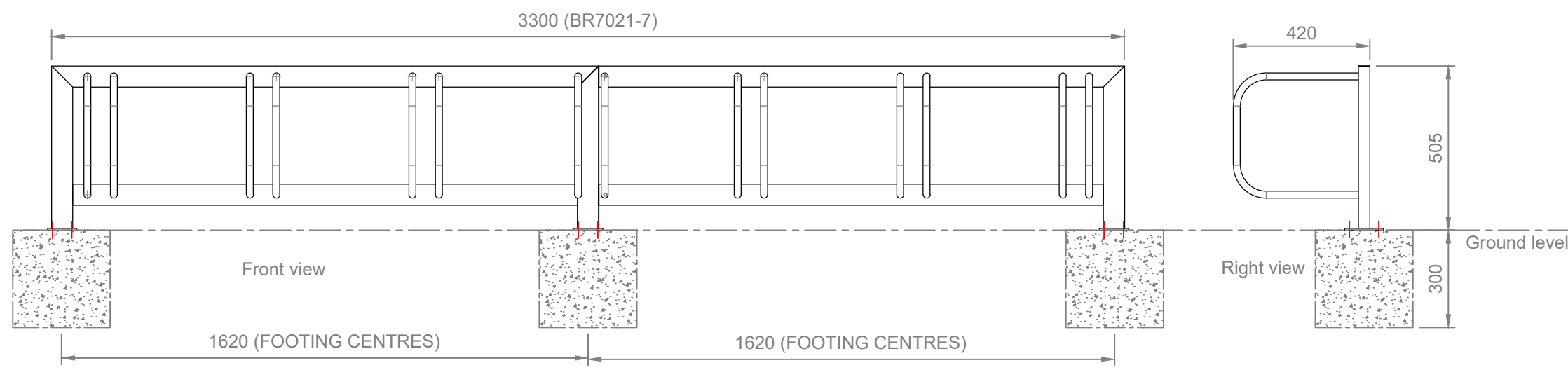
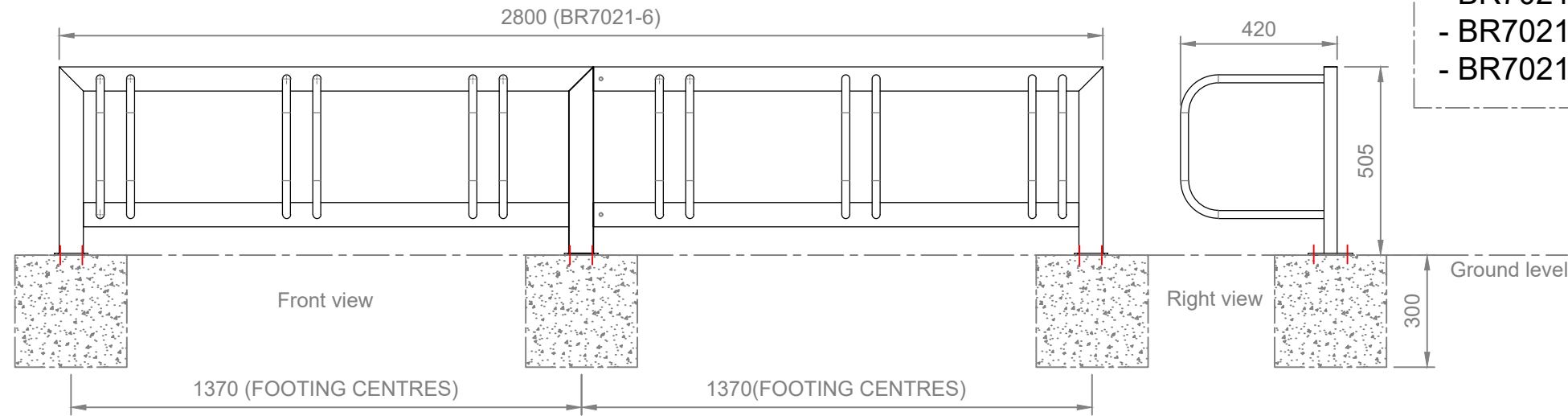

INSTALLATION DETAILS (Recommendations only)

Concrete footings, 25mPa:

- Three 300x300x300mm minimum footing size
- Bolt to footings with 12x M12x75mm Dynabolts or similar or

Concrete slab, 25mPa:

- BR7021-6: One 2950x550x100mm (minimum) thick slab
- BR7021-7: One 3450x550x100mm (minimum) thick slab
- BR7021-8: One 3950x550x100mm (minimum) thick slab



Commercial Systems Australia Pty. Ltd.

42 Orchard St, Kilsyth South, VIC

phone: (03) 9723 4111

fax: (03) 9723 3494

email: design@commercialsystems.com.au

Model Code: BR7021-6, -7, -8

Model Description: Multi Bike Rack

Drawing: CS0345

Sheet Number: -

Sheet Description: Installation

Drawn By: G.Smith

Date Drawn: 29.07.2011

Revision Number: 3

SCALE 1:1

ALL DIMENSIONS IN MILLIMETERS
UNLESS OTHERWISE STATED
ALL PARTS CENTRED UNLESS SPECIFIED

TOLERANCES

X	+/- 1mm
X.X	+/- 0.5mm
X.XX	+/- 0.05mm