

Fine Public Furniture

Commercial Systems

Australia Pty. Ltd.



Commercial Systems Australia Pty Ltd



Leading in Creative Design - Product Development - Manufacturing Technologies

At Commercial Systems Australia we dare to think outside the square. Listening to your ideas and aspirations we handcraft award winning street furniture solutions and more.

Our unique mix of design and manufacturing technologies allow us to create amazing furniture and structures to make the clear statement that your project is unique.

We have our own dedicated design team utilising 2D and 3D CAD design suites to bring your ideas to life. This flexibility allows you to break free from the standard street furniture styles.

So if you are looking outside of the square and you need a partner to design and manufacture or just need something a little different, please give us a call.

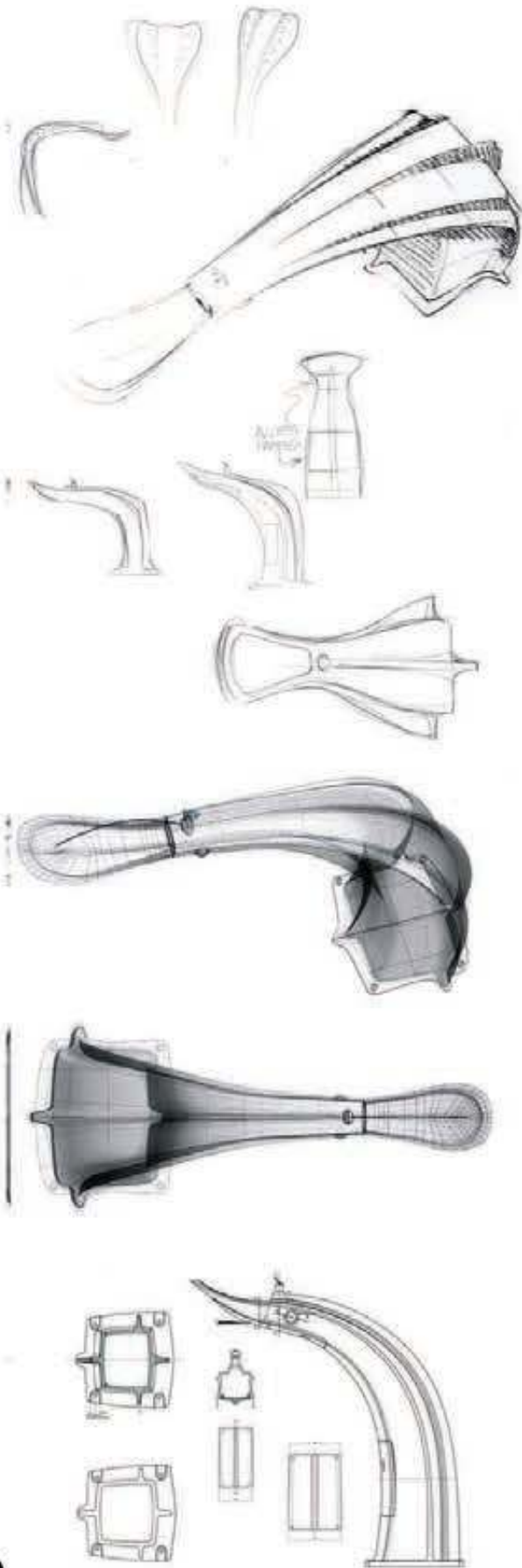

About Us

Commercial Systems Australia have been the proud manufacturers of public furniture items for over 20 years. With customers throughout Australia, New Zealand, South East Asia and United Arab Emirates, wherever people meet, you will find attractive, durable, public furniture produced by Commercial Systems Australia Pty Ltd. Designers, manufacturers and installation contractors of quality public furniture for:

- Shopping Centres
- Streets and Malls
- Schools and Universities
- Sporting Venues
- Entertainment Centres
- Parklands

DESIGN

Commercial Systems Australia Pty. Ltd. employs qualified Designers, Engineers and Interior Designers to assist in the development of concept ideas through to full computer aided shop drawings. Trained in the finer skills of shape, materials, ergonomics and colour, our design staff offer the opportunity for unique furniture to suit your project.

MANUFACTURE

Skilled timber and architectural metal workers combine select quality materials and the most modern tooling and machinery to produce public furniture to the highest world standards. Manufactured in our factory in Melbourne.

INSTALLATION

Commercial Systems Australia Pty. Ltd. installation teams have successfully undertaken projects from the largest shopping centres to full streetscape and mall construction. Our experienced installers have the expertise and equipment to carry out every type of site installation.

Proudly Australian Owned, Australian Made.

Quality Policy Statement

Commercial Systems Australia Pty. Ltd is committed to providing products and services of world-class quality standards. We always recognise the quality required by our customers and will guarantee those standards by:

- Using skilled labour, quality materials and first class machinery at all times.
- Continually training our staff to improve and develop their manufacturing skills.
- Develop and maintain a close liaison with our customers to ensure total understanding of their requirements.
- Continual review of design, materials and production techniques to ensure our products are manufactured to acceptable world standards.

Contents

Heavy Metal Seating	4
Perforated Metal Seating	6
Expanded Metal Seating	8
Timber and Metal Seating	9
Cast Furniture	18
Solid Timber Seating	21
Picnic Settings	22
Bike Racks	29
Litter Receptacles	30
Drinking Fountains	38
Planter Boxes	40
Bollards	42
Pedestrian Barriers	45
Tree Guards	49
Transit Shelters	51
Directory Boards	57



**Commercial Systems
Australia Pty Ltd**

49-51 Vinter Avenue
Croydon 3136 Victoria Australia
Phone (03) 9725 9344
Fax (03) 9725 9744
Email admin@commercialsystems.com.au
www.commercialsystems.com.au

Heavy Metal Furniture, designed and manufactured to withstand the toughest environments. Zinc or galvanised coatings protect against rust and corrosion. Finished in tough polyester powdercoat in your specified colour.



HM 3001 Circular End Seat

Steel slat seat with mild steel angle end frame. Standard lengths 1500mm, 1800mm, 2000mm, 2400mm. Available in mild steel or stainless steel.

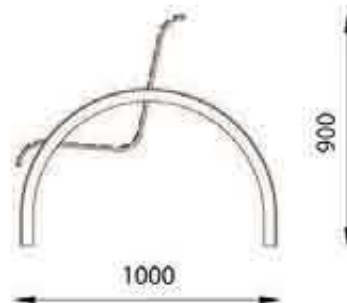

HM 3005 Quadrant End Seat

Steel slat seat with tubular quadrant end frame. Standard lengths 1500mm, 1800mm, 2000mm, 2400mm. Available in mild steel or stainless steel.



HM 3010 Standard Steel Slat Bench

Compliments HM 3020 Seat. Standard lengths 1500mm, 1800mm, 2000mm, 2400mm. Available in mild steel or stainless steel.

Option: Available in 690mm width HM 3010W

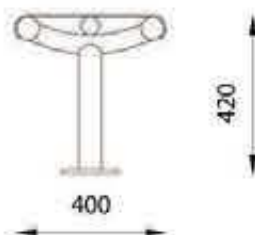

HM 3012 Lowline Bench

Steel slat bench with feature closed end. Standard lengths 1500mm, 1800mm, 2000mm, 2400mm. Available in mild steel or stainless steel.

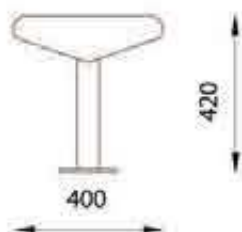

HM 3020 Standard Steel Slat Seat

Compliments HM 3010 Bench. Standard lengths 1500mm, 1800mm, 2000mm, 2400mm. Available in mild steel or stainless steel.

Also available curved or circular (refer HM 3050).





HM 3030 Derwent Seat

Steel slat seat with square tube end frames. Manufactured straight HM 3030 or curved HM 3031. Standard length 2000mm. (straight)

HM 3031 curved to your required radius. Convex or concave. Available in mild steel or stainless steel.

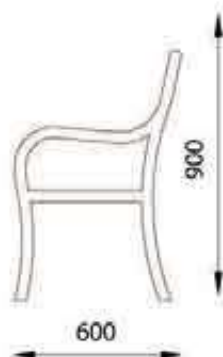

HM 3035 Steel Slat Arch Leg Seat

Available in mild steel or stainless steel. Standard lengths 1500mm, 1800mm, 2000mm and 2400mm.

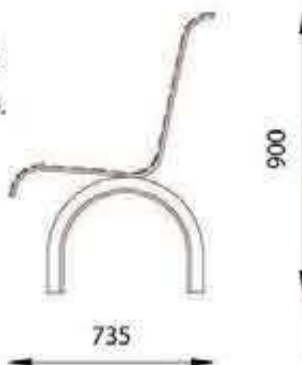

HM 3040 Rolled Tubular End Steel Slat Bench

Available in mild steel or stainless steel. Standard lengths 1500mm, 1800mm, 2000mm and 2400mm.

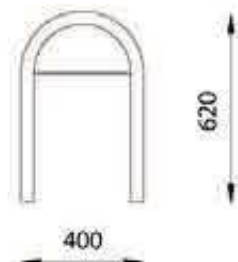

HM 3050 Curved Steel Slat Seat

Available curved or circular. Curved to your required radius. Available in mild steel or stainless steel. Also available straight (refer HM 3020).

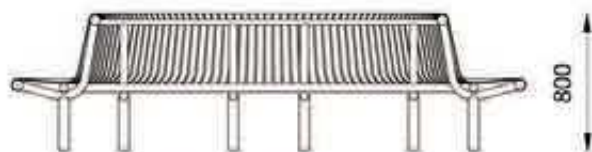

VARIABLE RADIUS



HM 3062 Bum Rail

Available in mild steel or stainless steel. Standard lengths 1500mm, 1800mm, 2000mm and 2400mm.

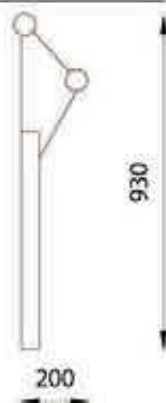

Perforated Metal Furniture, the economical solution that provides durability and strength under all conditions. Dissipates heat and cold for year round comfort.

PM 2006
Circular End Seat

Steel angle end frame.
Standard length 1800mm.

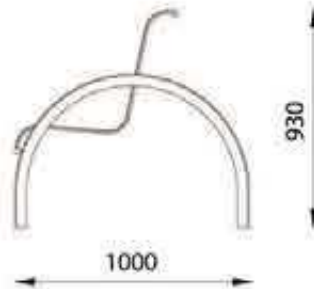

PM 2010
Wall Mounted Seat

Standard lengths 1200mm, 1500mm
1800mm and 2400mm.



PM 2018
Standard Perforated
Seat

Standard lengths 1200mm,
1500mm and 1800mm.

Compliments PM 2040 Bench
and PM 2045 Picnic Unit.



PM 2035
Wall Mounted Bench with Tubular Frame

Standard lengths 1200mm, 1500mm
and 1800mm.

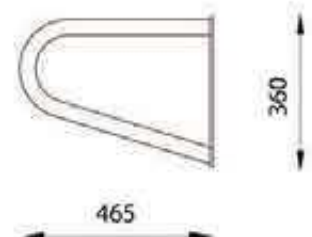

PM 2040
Lowline Bench

Standard length 1200mm,
1500mm and 1800mm.

Compliments PM 2018 Seat
and PM 2045 Picnic Unit.

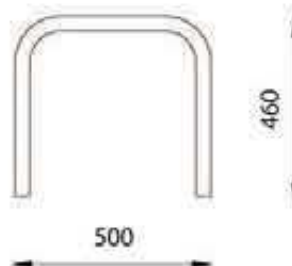

PM 2043
Outer Circle Seat

Compliments PM 2046
Picnic Table.
Standard length 1800mm.



PM 2093
Wide Double Sided Bench

Recommended in stainless
steel. Also available in
powdercoated mild steel.
Standard length 1800mm.



PM 2094
Industry Seat

Pictured here with complimentary
style Litter Bin LR 6061.
Standard length 1800mm.

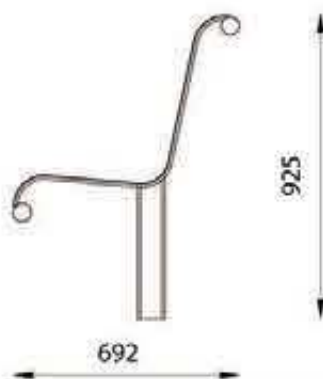

PM 2095B
Watsonia Bench

Compliments PM 2095
Picnic Unit.
Standard length 1800mm.

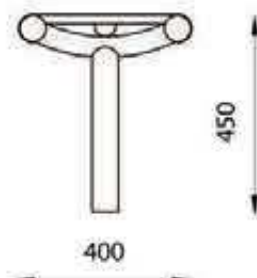

PM 2097
Slimline Bench

Economical seating for Schools
and Universities.
Compliments PM 2098
Slimline Picnic Table.
Standard length 1800mm.

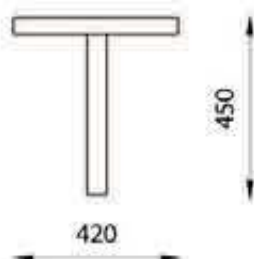

Expanded Metal Seating for heavy duty applications where utmost strength is required. Mild steel finished in tough polyester powdercoat coloured to your specifications. Skateboard impediments available on request.



Bayview Cast End Range

Expanded mesh panel with feature cast aluminium ends. Standard length 1800mm.

- EM 3002 Bayview Seat
- EM 3001 Bayview Bench

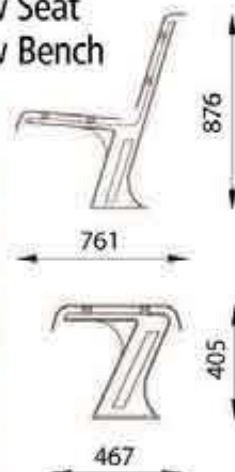

Skate Park Range

Expanded mesh seating panels with mild steel frame. EM 3004 seat available with or without arms. Standard length 1800mm.

- EM 3004 Skate Park Seat
- EM 3005 Skate Park Bench

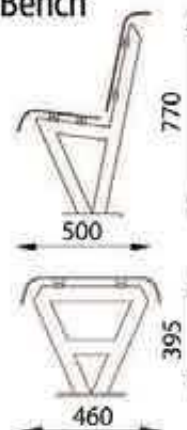

EM 3012 Stainless Steel Mesh Inground Seat

Full stainless steel mesh Seat and back panels with laser cut frame. Also available in mild steel. Standard length 1800mm.



Timber slat seats using only the finest class 1 durability Australian hardwoods. Standard finish by deep immersion in protective Quantum Oil. Consider using 100% recycled plastic slats in preference to timber slats in this range.

TM 4012 Octagonal Seat

Custom manufactured as curved, round or octagonal.



TM 4020 Standard Tubular End Seat

Timber slats with tubular metal frame ends.
Standard Length 1800mm.

Compliments TM 4030 Bench.



TM 4030 Lowline Bench

Timber slats with tubular metal frame ends.
Standard length 1800mm.

Compliments TM 4020 Seat.

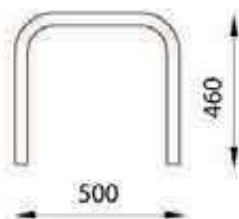

TM 4032 Quadrant End Seat

Timber slat seat with angle quadrant end frames.
Standard lengths - 1500mm, 1800mm, 2000mm and 2400mm.

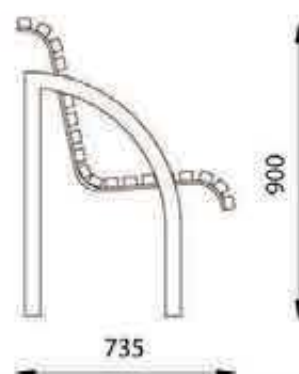

TM 4035 Vertical Slat Seat with Arms

Roll profiled end slats.
Available with timber slat arms.
Standard length 1800mm.

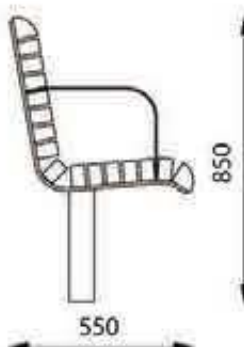

TM 4036
Vertical Slat Seat

Roll profiled end slats.
Standard length 1800mm.

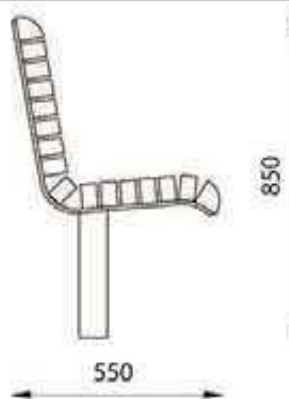

TM 4040
Yard Bench

Ideal for the school yard.
Available with 90mm x 30mm slats (TM 4040) or in 60mm x 30mm slats (TM4041).
Available in any length module for any required configuration.
Standard length 1800mm.

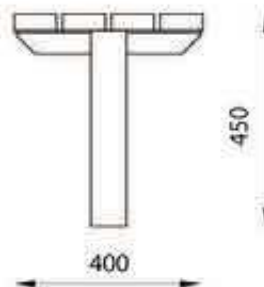

TM 4042
Yard Seat

Ideal for school recreation areas.
Compliments the TM 4041 bench.
Standard length 1800mm.



TM 4043
H Frame Yard Bench

Economic seating solution
for Schools.
Standard length 1800mm.

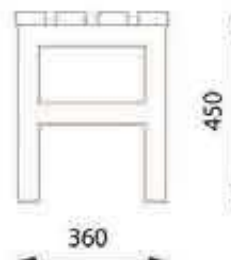

TM 4050
Standard Park Seat

Vertical 60mm x 40mm timber
slat Seat.
Compliments the TM 4053
Bench and the TM 4054 Table.
Standard lengths 1800mm
and 2400mm.

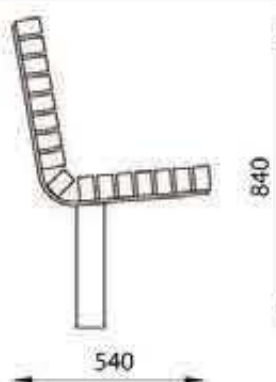

TM 4053 Park Bench

Vertical 60mm x 40mm timber slat Bench.

Available in any length module for any required configuration.

Compliments TM 4035 Seat, TM 4050 Seat and TM 4054 Table.

Standard length 1800mm and 2400mm.

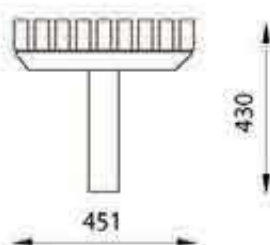

TM 4053 MITRED Mitred Park Bench

Available in any length module for any required configuration.

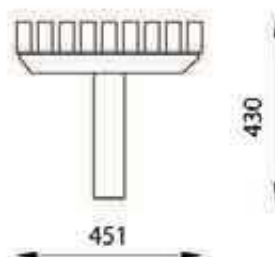

TM 4064 Albert Park Seat

Park seating at its relaxed best. Standard length 1930mm.

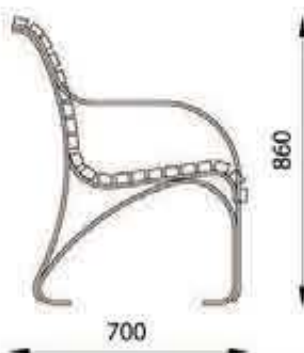

TM 4065 Classic Seat

Graceful but robust – this is a classic style.

Compliments TM 4135 bench. Standard length 2000mm.

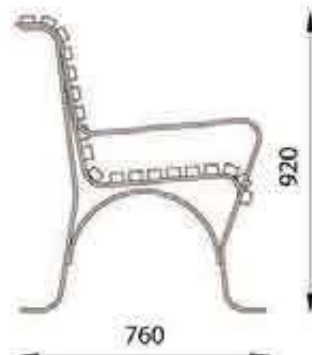

TM 4067 Garden Seat

Elegant park seating. Standard length 2000mm.



**TM 4068
Botanic Seat**

The original 1910 design Seat. And still in use. Standard length 1800mm. Also available fully painted in Red Two Pack Polyurethane finish for original Royal Botanic Gardens design.

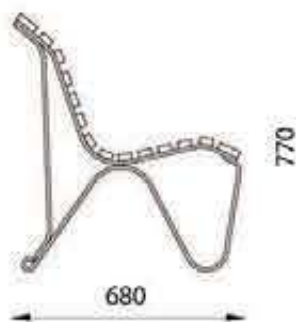

**TM 4074
Plaza Seat**

Fabricated steel frame with timber back and seat. Available with or without arms. Standard length 2000mm.

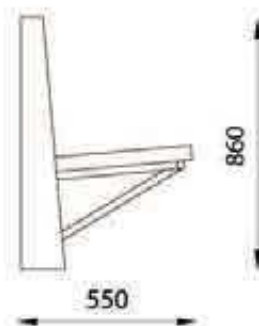

**TM 4080
Courtside Seat**

Spectator Seat ideally suited to tennis and bowling venues. Standard length 1800mm.

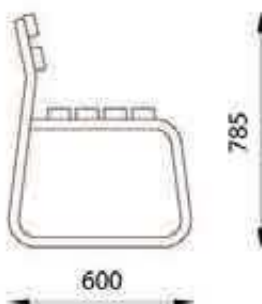

**TM 4115
Albert Park Bench**

Contoured laser profile. Compliments Picnic Table TM 4116. Standard length 1930mm.

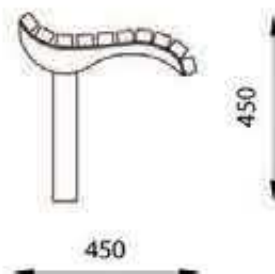

**TM 4135
Classic Bench**

Wide, double sided Bench. Compliments the TM 4064 and TM 4065 Seats. Standard length 2000mm.

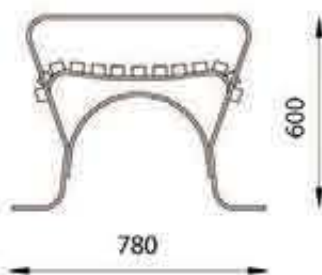

TM 4137
Traditional Bench

Wide, double sided Bench. Also available in single width (590mm) as TM 4136. Standard length 1800mm.

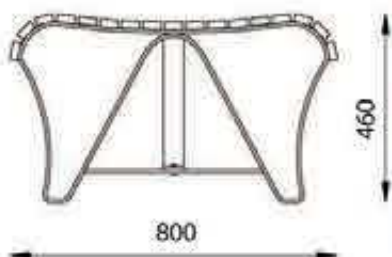

TM 4140
Contour Bench

Ergonomic contoured double sided Bench. Also available in single width as TM 4114. Standard length 1800mm.

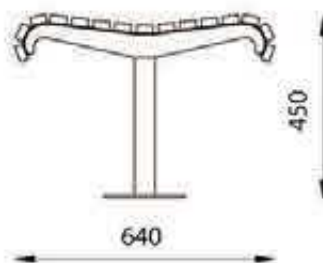

TM 4156
Contour Seat

Round tube fabricated post and beam Seat. Standard length 1800mm.

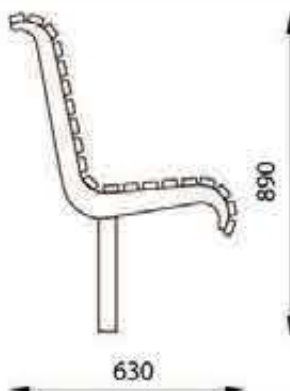

TM 4158
Burberry Seat

Square fabricated post and beam Seat. Standard length 1800mm.



TM 4185
Marina Seat

Post and beam Seat. Standard length 1800mm.

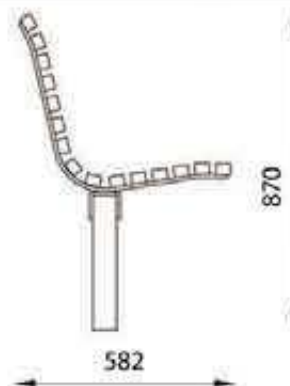

TM 4186
Portsea Seat

Stainless steel frame and arm rests.
Ideal for coastal applications.
Standard Length 1800mm.



TM 4195
Village Bench

Compliments the LR 6080 Litter Bin, BA 8000 Pedestrian Barrier and TG 1061 Tree Guard.
Standard length 1800mm

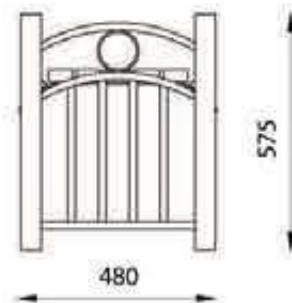

TM 4230
Kingsclere Seat

Fabricated steel frame with timber arm rests.
Standard length 1800mm.

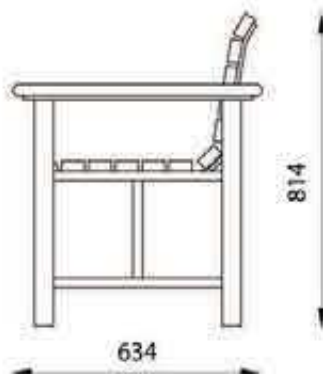

TM 4310
Yarrowonga Wave Bench

Feature wave style Bench.
Standard length 1800mm.

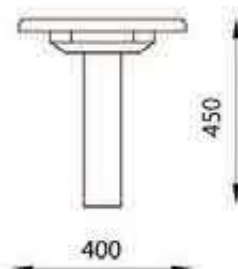

TM 4311
Yarrowonga Wave Seat

Feature wave style Seat.
Standard length 1800mm.

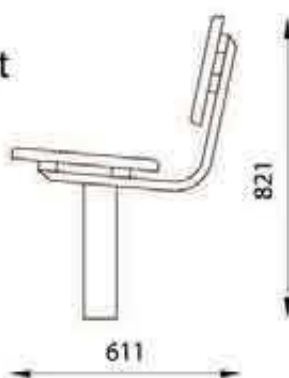

TM 4315 Valley Seat

Rolled tubular frame Seat shown with recycled plastic slats. Also available with hardwood slats. Standard length 1800mm.



TM 4320 The Hills Seat

Laser cut design end panel can be customised with your logo. Mild steel frame and arm rests. Standard length 2300mm. Interchangeable back rests. (Designed by Hassell Pty Ltd).

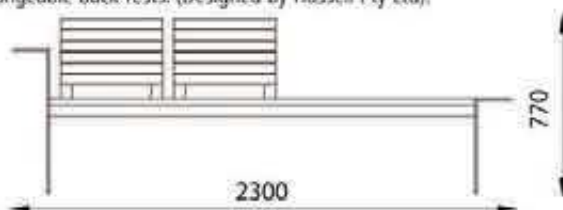

TM 4324 Platform Bench

Shown in 40mm x 30mm slats. Also available in 60mm x 30mm slats. Standard size 1200mm x 1200mm x 550mm high and 1800mm x 1800mm x 550mm high.



TM 4360 Malibu Seat

Seaside theme design Seat. Standard length 1800mm.

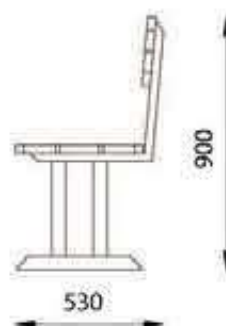

TM 4385 Highpoint Bench

Stainless steel frame and arms with aluminium slats. Available also in powdercoated mild steel with timber slats. Standard length 1800mm.

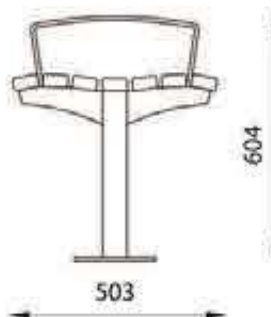

Extruded Aluminium

Extruded aluminium can replace timber slats on our cast or timber and metal range of furniture. Just ask us how.

- Looks great
- Low maintenance
- Easy to clean
- Aluminium will not fade or deteriorate over time
- Termite resistant
- High resistance to vandalism



Recycled Plastic

Replace timber slats with recycled plastic slats on our cast or timber and metal range of furniture. Just ask us how.

- Low maintenance
- Easy to clean
- Termite resistant
- Will not split or rot
- Reduces waste from landfill
- Wood conservation



Sleek, strong cast aluminium frames with optional Class 1 durability Australian hardwood slats, extruded aluminium slats or recycled plastic slats.

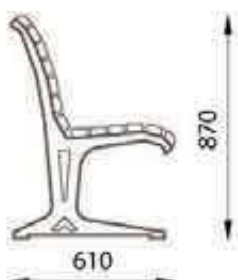

ESPLANADE RANGE

Contemporary cast aluminium ends - strong, corrosion resistant. Castings to suit 60mm x 30mm timber slats.
 TM 4200 Esplanade Seat. Optional arm rests.
 TM 4205 Esplanade Bench.
 TM 4210 Esplanade Table. (Refer page 26)
 Standard length 1800mm.



TM 4225 Stonnington Seat

Heavy cast frame with prominently cast logo or name.
 Standard length 1800mm.



GOTHIC RANGE

Elegant cast aluminium frame Seat and Bench with 40mm x 30mm timber or 40mm x 20mm aluminium slats.
 TM 4250 Gothic Seat. Optional armrests.
 TM 4255 Gothic Bench.
 Standard length 1800mm.

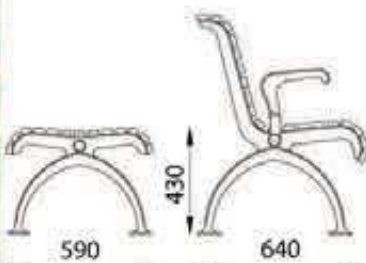



TM 4259



WYNDHAM RANGE

Versatile cast end range of furniture featuring Victorian Ash timber slats for internal use, Ironbark timber or aluminium slats for external use.

TM 4259 Wyndham Seat. Optional arm rests.

TM 4258 Wyndham Bench.

TM 4257 Wyndham Wall Mounted Bench.

TM 4254 Wyndham Wall Mounted Seat.

TM 4256 Wyndham Table (refer page 26).

Standard length 1800mm.



TM 4258

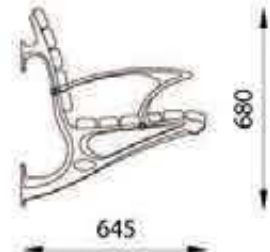

TM 4257

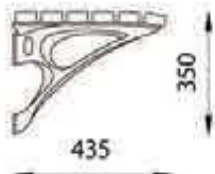

TM 4254



TM 4275



FLINDERS FURNITURE RANGE

Classic cast aluminium frame furniture stylishly designed to suit 60mm x 30mm timber slats.

TM 4275 Flinders Seat.

TM 4270 Flinders Bench.

TM 4280 Flinders Table (refer page 27)

Standard length 1800mm.

TM 4285 Flinders Side Table.



TM 4270



TM 4285



CHIFFLEY SEATING RANGE

Contemporary cast aluminium ends - strong, corrosion resistant. Castings to suit 60mm x 30mm timber slats.
 TM 4301 Chiffley Seat.
 Standard length 1800mm.

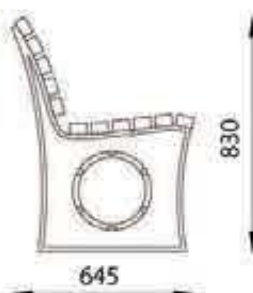

BASS SEATING RANGE

Coastal inspired porthole cast Seat and Bench ends. Also available with or without custom made logo cast infills.
 TM 4303 Bass Seat.
 TM 4304 Bass Bench.
 Standard length 1800mm.

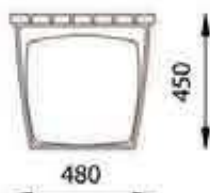
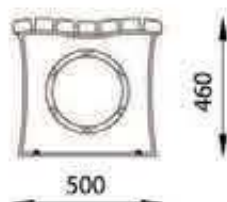

NEPEAN SEATING RANGE

Sophisticated yet elegant cast aluminium ends. Creative changes are made to the look and feel of this range by using a variety of powdercoat colours, various timbers and aluminium slats.
 TM 4307 Table (refer page 27).
 TM 4308 Nepean Bench.
 TM 4309 Nepean Seat.
 Standard length 1800mm.



Solid timber seats are often specified for parkland, rural and coastal projects where the style integrates well with the natural surroundings. Solid timber traditional heritage style Seats are available in solid Jarrah for external use or Victorian Ash for internal use. Craftsmen made with all joints mortise and tenoned and marine glued to provide exceptional durability under the heaviest use conditions.

TM 4150 Mayfair Seat

Solid Victorian Ash Seat finished in clear polyurethane. Ideal for shopping centres. Compliments the TM 4151 Bench, LR 6175 Bin and PB 1567 Planter Box. Standard lengths 1200mm, 1500mm and 1800mm.



TM 4150 Mayfair Seat

Solid Jarrah Seat finished in clear Jarrah Oil. Ideal for seaside locations. Compliments the TM 4151 Bench, LR 6175 Bin and PB 1567 Planter Box. Standard lengths 1200mm, 1500mm and 1800mm.



TM 4152 Picadilly Bench

Solid Victorian Ash or Jarrah Bench. Also available with arms TM 4151. Standard lengths 1200mm, 1500mm and 1800mm.

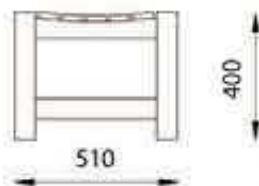

TM 4153 Park Lane Seat

Solid Victorian Ash or Jarrah Seat with arched back. Compliments the LR 6175 Bin and PB 1567 Planter Box. Standard lengths 1200mm, 1500mm and 1800mm.



Combination Unit and Picnic Settings, heavy duty commercial quality settings for schools, parks and entertainment venues. Your choice of steel or cast frames with perforated metal, hardwood, aluminium or recycled plastic slats. Products shown with wheelchair logo are available as modified for wheelchair access.



PM 2033

Arched Pedestal Picnic Unit

Perforated metal Table and Stools. Standard Table length 1500mm. Standard Stool 320mm Ø

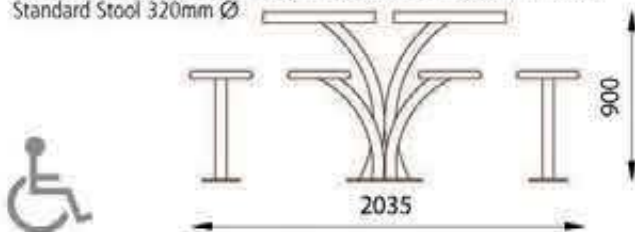

PM 2045

Perforated Metal One Piece Setting

Standard length 1800mm

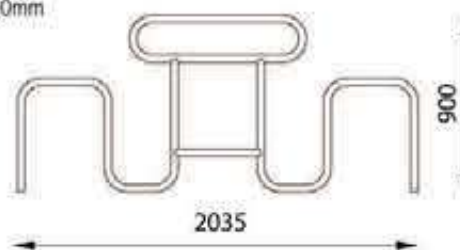

PM 2046 Table PM 2040 Bench
Outer Circle Setting

Perforated metal Table PM2046 with complimenting Bench PM 2040. Standard length 1800mm.

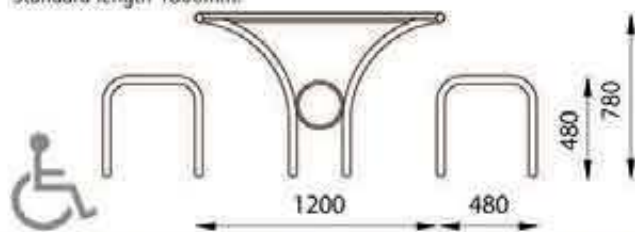

PM 2046 Table PM 2043 Seat
Outer Circle Setting

Perforated metal Table PM2046 with complimenting Seat PM 2043. Standard length 1800mm.

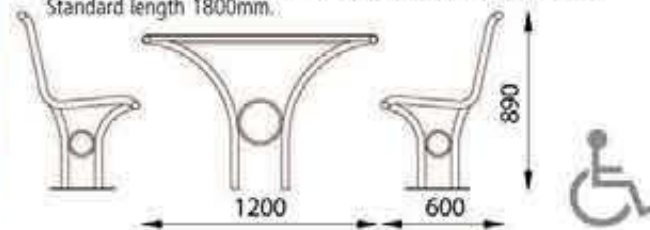

PM 2050 Table PM 2053 Stools
Perforated Cafe Setting

Perforated metal Table PM2050 with perforated metal Stools PM 2053.

Standard Table sizes:

- 600mm Ø
- 750mm Ø
- 750mm x 750mm square
- 1100mm Ø

Standard Stool size:
320mm Ø

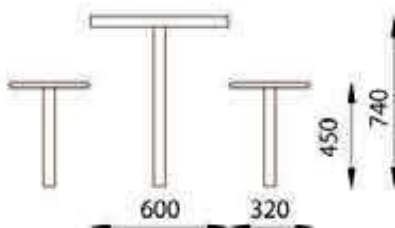

PM 2095
Watsonia Picnic Setting

Perforated metal Table and Bench Setting.
Standard length 1800mm.

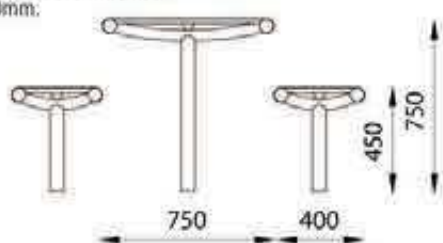

PM 2096
College Perforated Metal Setting

Single pedestal Picnic Table with Benches.
Standard size 1900mm x 1900mm.

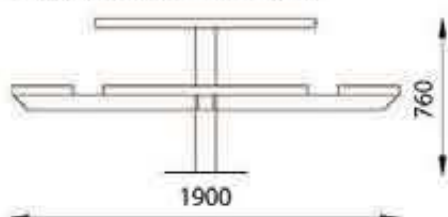

PM 2098 Table PM 2097 Bench
Slimline Perforated Metal Setting

Economical, space saving Picnic Table and Benches.
Wheelchair accessible.
Standard length 1800mm.

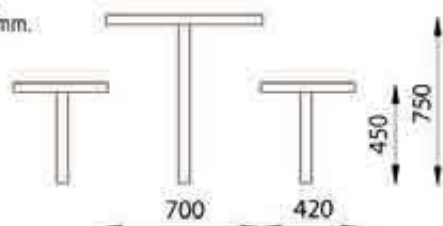

HM 3045 Table HM 3010 Bench
Steel Slat Setting

Robust mild steel slat Table and Benches. Also available in stainless steel.
Standard length 1800mm.



HM 3045 Table HM 3020 Seat
Steel Slat Setting

Robust mild steel slat Table and Seats. Also available in stainless steel.
Standard length 1800mm.



TM 4053 Bench TM 4054 Table
Vertical Timber Slat Picnic Setting

Also ideal for recycled plastic slat application.
 Standard length 1800mm.

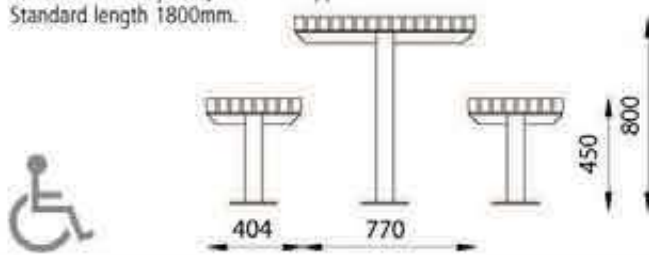

TM 4101
Standard Picnic Setting

Tubular mild steel frame and timber combination unit.
 Standard length 1800mm.

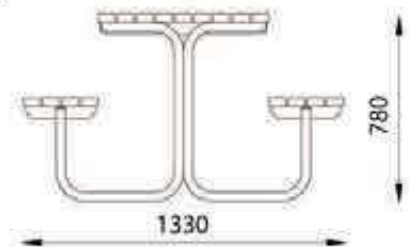

TM 4110
Solid Cypress Pine Combination Unit

Robust A frame picnic unit built to withstand heavy commercial use.
 Standard length 1800mm.

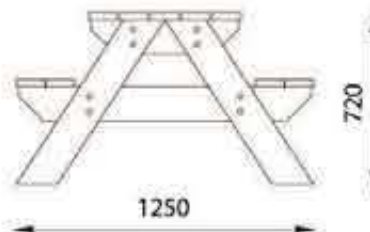

TM 4115 Bench TM 4116 Table
Albert Park Picnic Setting

Stainless steel Table top. Contoured timber Benches.
 Standard length 1930mm.



TM 4114 Bench TM 4117 Table
Hobson Picnic Setting

Timber Table top and Benches.
 Standard length 1930mm.

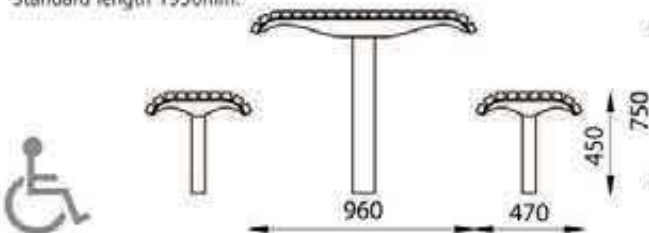

TM 4120
Koornang Setting

Single pedestal Table with Benches. Ideal setting for wheelchair access.
 Standard length 1800mm.

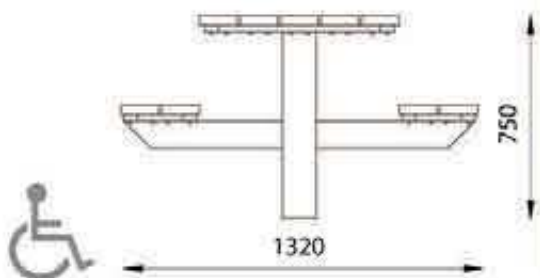

TM 4122
Valley Setting

Single pedestal mild steel frame with timber table and Benches.
 Standard length 1800mm.

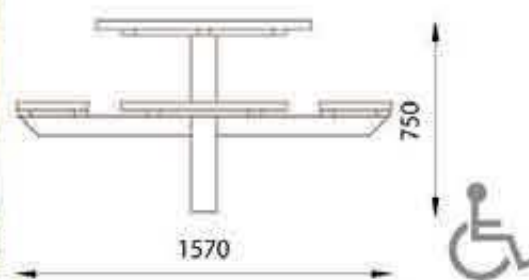

TM 4125
Nunawading Setting

Timber and steel Picnic Setting. Single unit frame with 'L' shape seats.
 Standard length 1570mm x 1570mm.

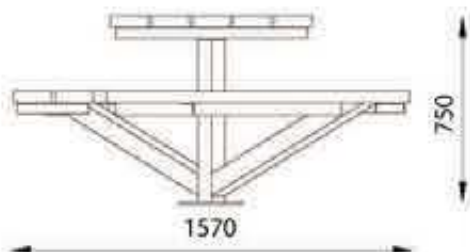

TM 4127
Ormond Setting

Tubular mild steel frame with timber Table top and Benches.
 Ideal setting for wheelchair access.
 Standard length 1800mm.

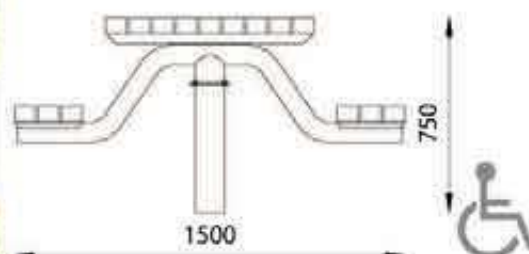

TM 4148 Table TM 4152 Bench
Picadilly Picnic Setting

Solid Jarrah Table and Bench Picnic Setting.
 Shown with optional inset chess board.
 Standard length 1800mm.

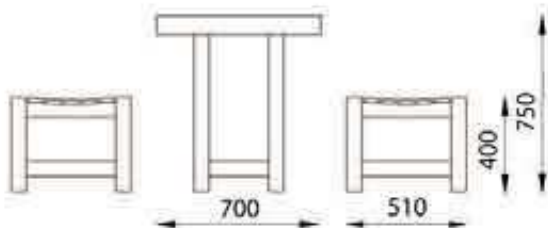

TM 4191
Olympic Picnic Setting

Timber and steel Picnic Table with curved Benches.
 Standard length 1900mm.

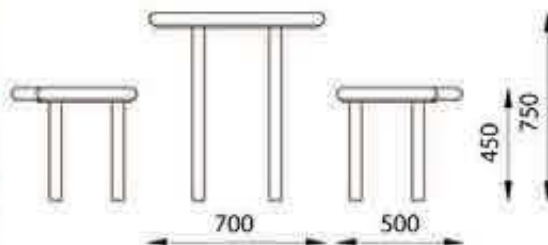

TM 4205 Bench TM 4210 Table
Esplanade Cast Picnic Setting

Contemporary cast aluminium ends - strong and corrosion resistant.
 Standard length 1800mm.

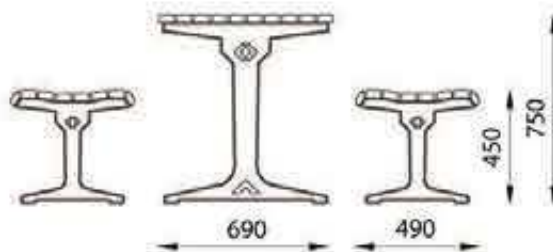

TM 4258 Bench TM 4256 Table
Wyndham Cast Picnic Setting

Stylish versatile setting which looks great with timber or aluminium slats.
 Standard length 1800mm.



TM 4270 Bench TM 4280 Table
Flinders Cast Picnic Setting

Classic cast aluminium frame.
 Standard length 1800mm.

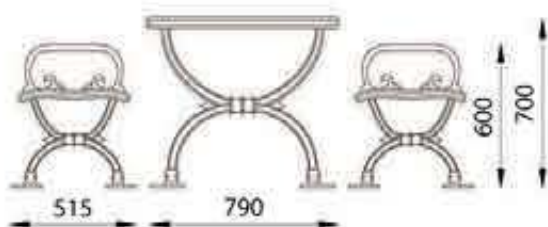

TM 4293
Garden Picnic Setting

Simple mild steel frame with timber slats.
 Standard length 1800mm.

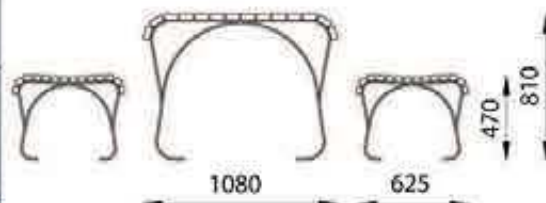

TM 4308 Bench TM 4307 Table
Nepean Cast Picnic Setting

Looks great with timber or aluminium slats.
 Standard length 1800mm.

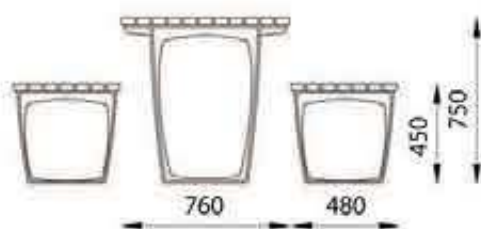

TM 4322
Hawthorn Setting

Mild steel H frame Table with Benches.
 Standard length 1800mm.

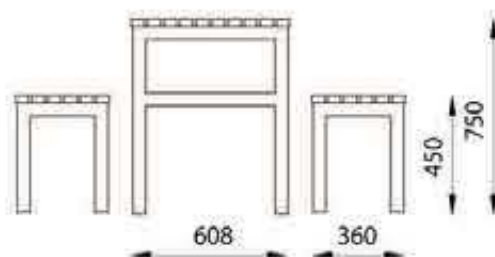

TM 4325
Apollo Picnic Setting

Stainless steel frame with timber slats.
 Standard length 1800mm.

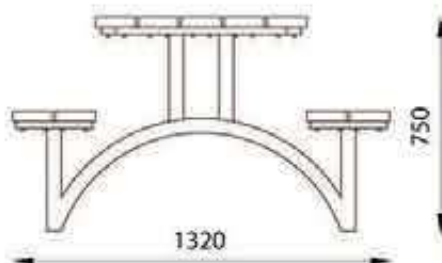

TM 4340
Mernda Picnic Setting

Mild steel flat bar frame with timber slats.
 Standard length 1800mm.

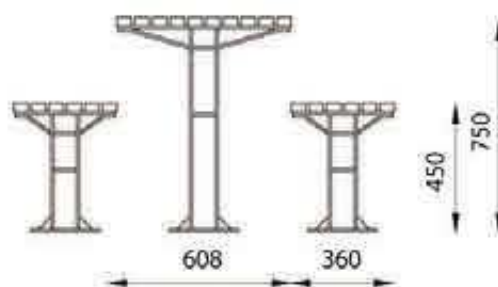

TM 4345
Tubular Frame Timber Slat Picnic Unit

Steel and timber single unit Setting.
 Standard length 1800mm.

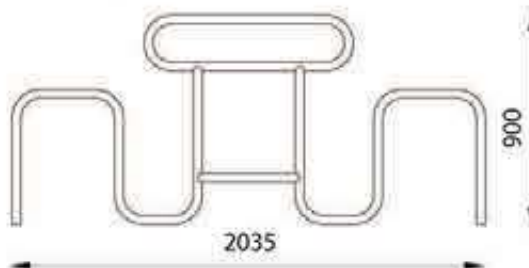

TM 4350
Berwick Curved Picnic Setting

Curved timber and metal Table with Benches.
 Standard length 2000mm.

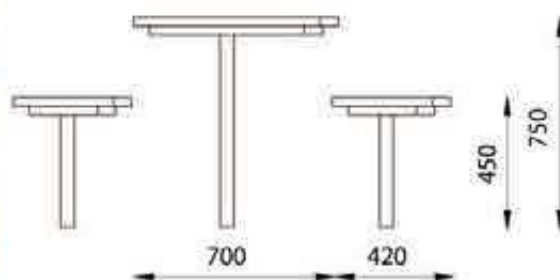

Bicycle racks and rails available in any length and capacity. Choose from galvanised, stainless steel or powdercoat finish in any specified colour. Inground or dynabolt fixing. Custom manufacturing available to your requirements.



BR 7002
Angle Bike Rack

Galvanised mild steel multi Bike Rack. Capacity as required. Fixing tabs for bolt fixing to ground.

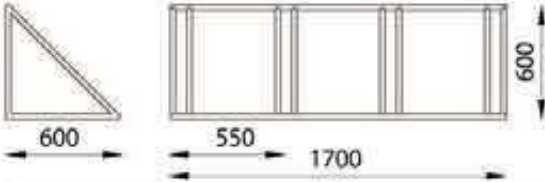

BR 7005
Single Pedestal Bike Rack

Galvanised mild steel duo Bike Rack.

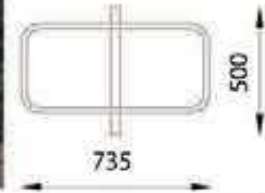

BR 7008, 7009, 7010, 7011, 7012, 7013, 7016
Bicycle Leaning Rails

A number of standard options are available as shown or request for custom manufacture to suit your requirements:

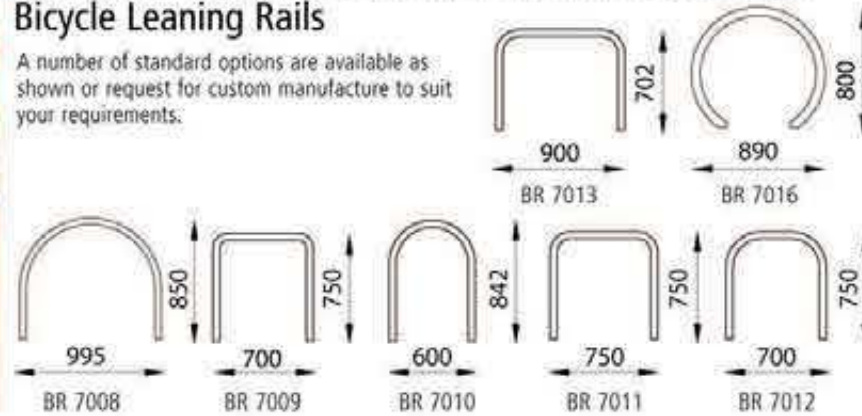

BR 7021
Multi Bike Rack

Made to suit bike capacity requirements. Available in single or double face, angled BR7022 or straight BR 7021.

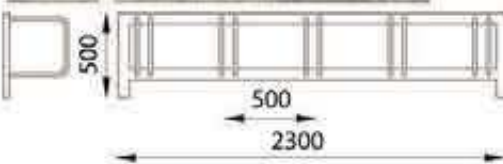

BR 7042
Loop Bike Rack

Galvanised mild steel or stainless steel tube Bike Rack.
BR 7040 Three bike capacity
BR 7041 Five bike capacity
BR 7042 Seven bike capacity

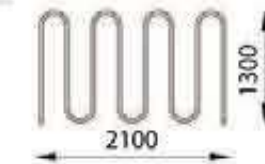

BR 7060
Bike Station

Single sided galvanised tubular steel Bike Rack. Custom made to suit client's specified capacity or length.

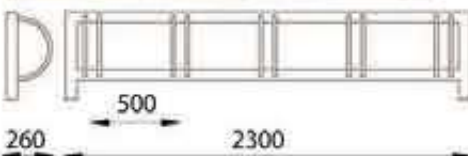

BR 7070
Cork Screw Bike Rack

Galvanised mild steel or stainless steel Bike Rack. Custom made to suit client's specified capacity or length.
Four bike capacity BR 7070.
Seven bike capacity BR 7071.

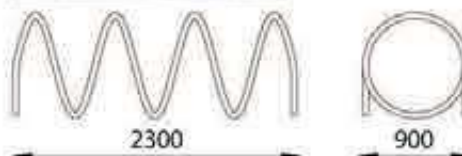

Commercial Systems Australia Pty Ltd manufacture the largest range of Litter and Smokers Bins for every application. All products may be modified to suit your requirements. Lids, locks and installation options are endless.

LR 6001
Heavy Duty
Smokers Bin

Post or wall fixed applications. Tapered top and internal butting plate for cleaner use.

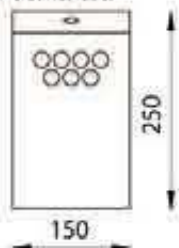

LR 6007
Bollard Front Entry
Smokers Bin

Key locked into standard SB 2015 Bollard. Ideal dual use of Bollards.



LR 6009
Bin Enclosure
Butt Bin

Stainless steel Smokers Bin fitted and locked into standard metal Bin Enclosure.

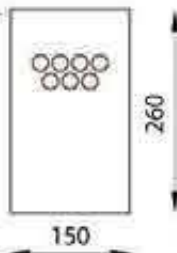

LR 6014
Wall Mounted
Smokers Bin

Stainless steel wall fixed Smokers Bin. Available with key lock for security.

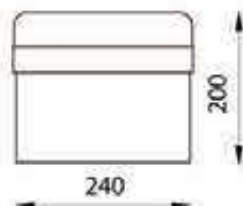

LR 6017
Hooded Wall
Mounted
Smokers Bin

Stainless steel wall fixed Smokers Bin.

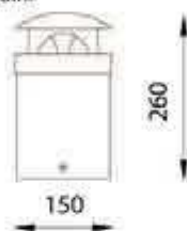

LR 6018
Bollard Top Entry
Smokers Bin

Stainless steel Bollard with key locked spring loaded Smokers Bin.

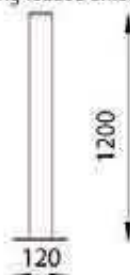

LR 6021
Standard Smokers
Stand

Aluminium ashtray lid anodised bright, gold or bronze.

Body in brushed stainless steel or powdercoated mild steel.



LR 6029
Funnel Top
Smokers Bin

Stainless steel Bin with funnel ash receptacle.





Stainless Steel Litter Bins

Galvanised inner liners supplied with all litter bins.

LR 6019 Ballasted base. Stainless steel lid, 200mm Ø x 600mm.

LR 6020 Ballasted Base. Stainless steel lid, 250mm Ø x 600mm.

LR 6022 Ballasted Base. Stainless steel lid, 320mm Ø x 600mm.

LR 6025 Optional aluminium funnel lid or stainless steel flat lid. 465mm Ø x 600mm.

LR 6026 Stainless steel lid, 465mm Ø x 750mm.

LR 6027 Stainless steel lid, 465mm Ø x 860mm.

LR 6028 Stainless steel lid, 600mm Ø x 800mm.

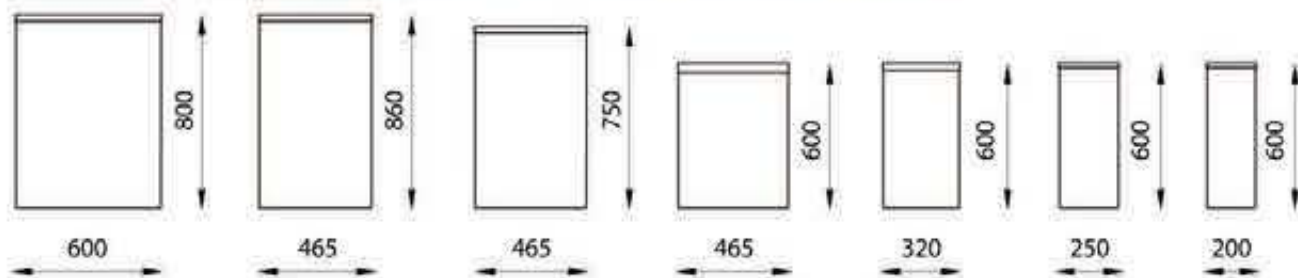

LR 6016 Wire Mesh Litter Bin

Wire mesh Bin with pedestal leg. Galvanised inner liner.

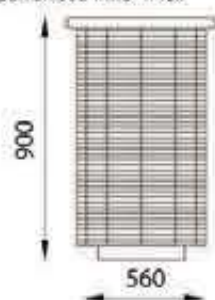

LR 6040 Yard Litter Bin

Standard timber slat Bin with pedestal leg. Galvanised inner Bin liner.

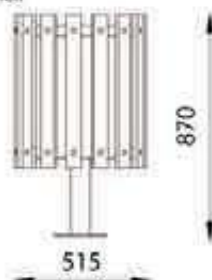

LR 6042 Cairns Bin

Mild steel powdercoated rings with vertical timber slats. Stainless steel donut lid. Galvanised inner Bin liner.



LR 6061 Freestanding Litter Bin

Stainless steel or powdercoated mild steel with stainless steel flat lid. Also available with bolt fix options. Galvanised inner liner.

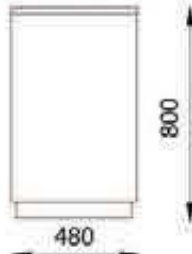

LR 6061 Cable Cable Tray Perforated Litter Bin

Available in different perforation styles, powdercoated or stainless steel body. Stainless steel flat lid. Galvanised inner liner.

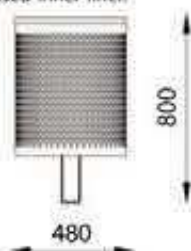

LR 6061 Slotted Slotted Perforated Litter Bin

Available in different perforation styles, powdercoated or stainless steel body. Stainless steel flat lid. Galvanised inner liner.

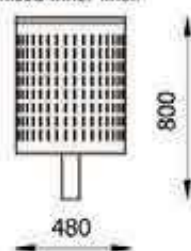

LR 6061 Stainless Stainless Steel Perforated Litter Bin

Available in different perforation styles, powdercoated or stainless steel body. Stainless steel flat lid. Galvanised inner liner.

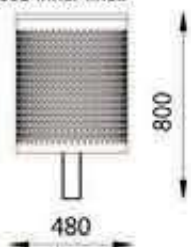

LR 6066 Laser Cut Litter Bin

Mild steel laser cut body with stainless steel lid. Galvanised inner liner.

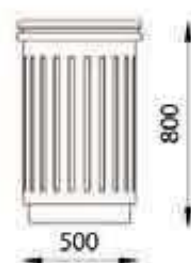

LR 6099 Transit Litter Bin

Standard mild steel slat Bin with pedestal leg. Galvanised inner liner.



LR 6103 Steel Slat Litter Bin

Freestanding or bolt fixed steel slat Bin with stainless steel lid. Galvanised inner liner.

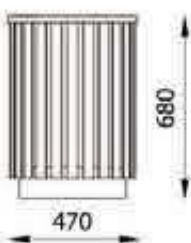

LR 6109 Donut Lid Litter Bin

Steel slat Bin with pedestal leg and donut lid. Galvanised inner liner.

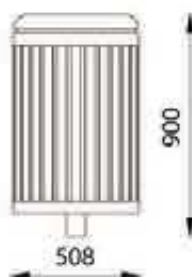

LR 6115 Circular Perforated Litter Bin

Mild steel perforated Bin with pedestal leg. Optional Bin lid available. Galvanised inner liner.

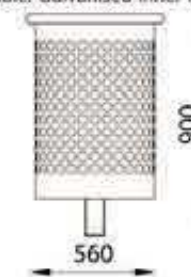

LR 6130
Kawana Steel Slat Litter Bin

Steel slat Bin with flared top. Galvanised inner liner.



LR 6136
Hobart Litter Bin

Fabricated mild steel Litter Bin with inset base. Mild or stainless steel lid. Galvanised inner liner.



LR 6140
Cylindrical Bin with Square Perforations

Mild steel Litter Bin with pedestal leg. Hinged stainless steel lid. Galvanised inner liner.

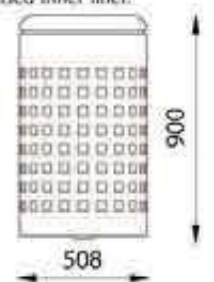

LR 6175
Solid Timber Litter Bin

Solid Jarrah or Victorian Ash (internal use only) Litter Bin with stainless steel lid. Galvanised inner liner. To suit Planter Box PB 1570.

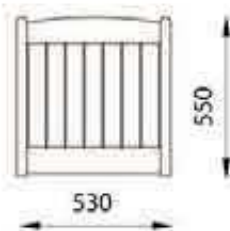

LR 6205
Manhattan Bin

Stainless steel Bin with donut lid. Side opening hinge. Optional key-locked Smokers Bin.



LR 6227
Camberwell Plaza Bin

Vertical timber slat Bin with stainless steel flat lid and inset base. Available in Ironbark or Tasmanian Oak.

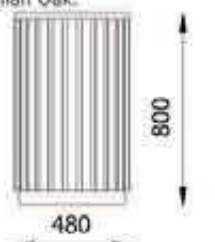

LR 6500
Doggie Bin

Mild steel powdercoated Bin with plastic bag dispenser and storage. Hinged lid and door. Galvanised inner liner.



LR 6520
Doggie Plastic Bag Dispenser

Plastic bag Dispenser for dog waste.

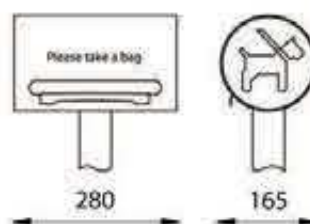

Commercial Systems Australia have the largest range of Bin Enclosures and Bin lids. Standard stock perforation style is 38mm x 38mm square and 38mm x 38mm triangular. Other perforation styles and laser cut logos are readily available, however prices may be adjusted depending on quantity of order. All Lids and Enclosure bodies are interchangeable and available in any combination.

The Bin Enclosure Range:

No need to order standards. You can mix and match to your requirements, so why not be creative.

1. Choose your size

- 120 Litre 240 Litre

2. Choose material for the body of the Bin Enclosure

- Mild Steel Stainless Steel Timber Slats Woven Stainless Steel

3. Choose what detail you like for the body of the Bin Enclosure

For Metal:

- Square Perforation Triangular Perforation Laser cut logo* Custom Perforation*

For Timber:

- Vertical Slats Horizontal Slats

4. Choose material for the lid

- Mild Steel Stainless Steel

5. Choose a style of lid

- Flat lid (waste)
 Flat Lid with Canopy (waste)
 Pyramid Top Entry* (waste)
 High Pyramid (recycling)
 Low Pyramid (recycling)
 Tapered Front Entry waste or recycling
 Curved Front Entry* waste or recycling
 Pyramid Front Entry* waste or recycling

6. Submit your specifications as above for detailed drawings and costings.

*minimum quantity order requirements.

LR 6158 SSF
120 litre Litter Bin Enclosure

Stainless steel flat lid.
Also available as 240 litre Enclosure LR 6164 SSF.

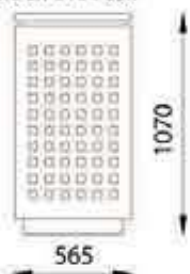

LR 6158 SSFC
120 litre Litter Bin Enclosure

Stainless steel flat lid with canopy.
Also available as a 240 litre Enclosure LR 6164 SSFC.

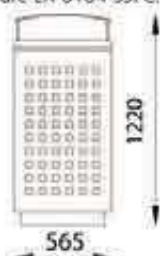

LR 6158 SSRH
120 litre Recycling Bin Enclosure

Fixed high peak pyramid style stainless steel recycling lid.
Also available as a 240 litre Enclosure LR 6164 SSRH.

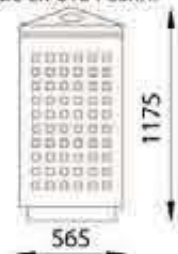

LR 6158 SSRL
120 litre Recycling Bin Enclosure

Fixed low peak pyramid style stainless steel recycling lid. Shown with the LR 6158 SSF (pictured on the right).
Also available as a 240 litre Enclosure LR 6164 SSRL.

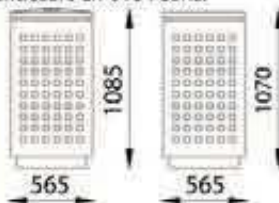

LR 6158 SSPT
120 litre Litter Bin Enclosure

Stainless steel pyramid top entry lid.
Also available as a 240 litre Enclosure LR 6164 SSPT.

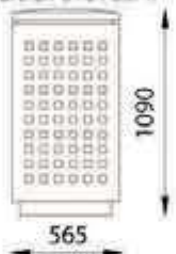

LR 6158 MSTF
120 litre Litter Bin Enclosure

Stainless steel or mild steel tapered front entry lid.
Also available as a 240 litre Enclosure LR 6164 MSTF.



LR 6158 SSCR
120 litre Litter Bin Enclosure

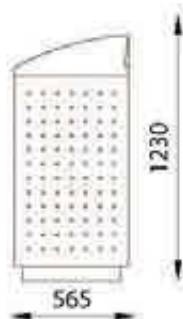

Curved recycling front entry, stainless steel lid (right). Shown with the LR 6158 SSCL stainless steel front entry litter lid (left).
Also available as a 240 litre Enclosure LR 6164 SSCR.

LR 6158 SSPF
120 litre Litter Bin Enclosure

Stainless steel high pyramid front entry lid.
Also available as 240 litre Enclosure LR 6164 SSPF.





LR 6158 SSF Custom 1
120 litre Litter Bin Enclosure

120 litre Litter Bin Enclosure with flat stainless steel lid. Request your own unique laser cut pattern and bin labels. Also available as custom 240 litre Enclosures.



LR 6158 SSF Custom 2
120 litre Litter Bin Enclosure

120 litre Litter Bin Enclosure with flat stainless steel lid. Request your own unique laser cut pattern and logo's. Also available as custom 240 litre Enclosures.

LR 6152 SSF
120 litre Laser Cut Bin Enclosure

Laser Cut Bin with wire mesh surround. Stainless Steel Lid.

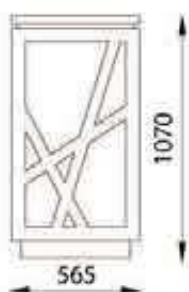

LR 6160
Seaside 120 litre Litter Bin Enclosure

Timber slats fixed to powdercoated non-corrosive aluminium frame.



LR 6161
Foreshore 120 litre Litter Bin Enclosure

Full timber slat Bin Enclosure with stainless steel flat lid.



LR 6163
120 litre Litter Bin Enclosure

120 litre Litter Bin Enclosure in select Hardwood slats with mild steel tapered front entry lid.



LR 6165
Double Wheely
Bin Security Posts

Suitable for 120 or 240 litre bins.
Key locked. Also available,
Single Wheely Bin Security Posts
LR 6166.

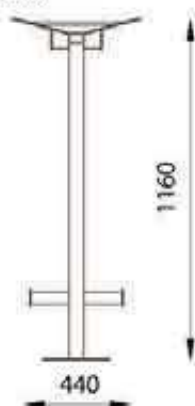

LR 6180 SSF
Village Style 120
litre Litter Bin
Enclosure

120 litre Litter Bin Enclosure.
Compliments the Village range
of Tree Guards, Benches and
Pedestrian Barriers.

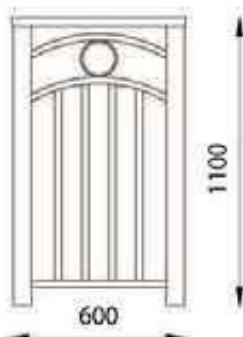

LR 6192
Seaside 240 litre
Litter Bin Enclosure

Seaside 240 litre Litter Bin
Enclosure in select Hardwood
slats. Shown without lid.
Available with fixed stainless
steel lid or with front entry
tapered lid.



LR 6216 SSF
120 litre Litter Bin
Enclosure

120 litre Litter Bin Enclosure
with vertical hardwood slats.
Stainless steel flat lid. Also
available with horizontal slats.

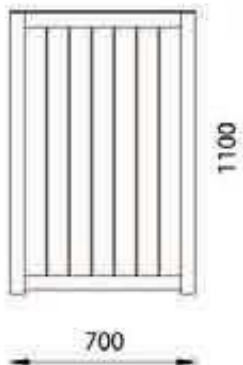

LR 6216 SSFC
120 litre Litter Bin
Enclosure

Stainless steel flat lid with
canopy. Also available with
horizontal slats.

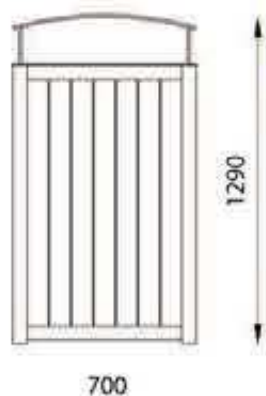

LR 6501
120 litre Wheely Bin

Available in 12 different colours.
Also available Standard 240 litre
Wheely Bin LR 6502.

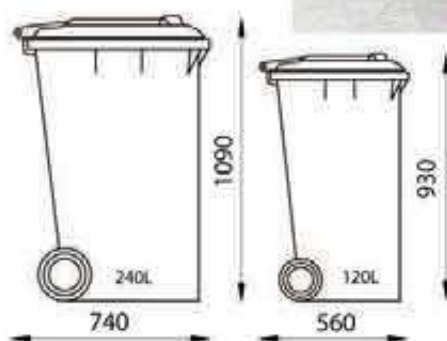

Designed for long term performance, Commercial Systems Australia Drinking Fountains provide a wide range of options to suit all types of applications. Drinking Fountains include internal plumbing and are ready for connection to services through the inspection doors. All connection work should be carried out by a licensed plumber.

DF 5001 Plaza Drinking Fountain

Tapered pedestal in stainless steel or powdercoated mild steel. Stainless steel arm, bowl and bubbler.



DF 5001 Plaza Drinking Fountain with Dog Bowl

Tapered pedestal in stainless steel or mild steel. Stainless steel arm, bowl and bubbler. Plus Dog Bowl.

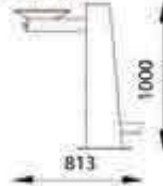

DF 5002 Portsea Drinking Fountain

Tapered pedestal Drinking Fountain. Stainless steel arm, covered bowl and bubbler.



DF 5002 Portsea Drinking Fountain with Dog Bowl

Tapered pedestal Drinking Fountain. Stainless steel arm, covered bowl and bubbler. Plus Dog Bowl.



DF 5035 Maroondah Drinking Fountain

Fabricated steel pedestal and stainless steel bowl. Designed for wheelchair access.



Commercial Systems Australia Wheel Chair friendly range of Drinking Fountains.

Optional features:

- Dog Bowls
- Side Taps
- Wall Mounted



DF 5040 Banyan Drinking Fountain

Heavy cast aluminium pedestal and bowl. Easy side button activation. Optional dog bowl as DF 5041.



DF 5041 Banyan Drinking Fountain

Heavy cast aluminium pedestal and bowl. Easy side button activation. With Dog Bowl.



DF 5005 Standard Drinking Fountain

Perforated pedestal in mild steel or stainless steel.
Stainless steel bowl.

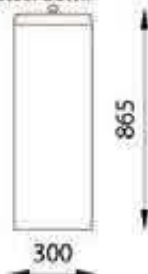

DF 5006 Park Drinking Fountain

Heavy mild steel pedestal with stainless steel bowl.



DF 5010 Heritage Drinking Fountain

Cast base with mild steel pedestal and stainless steel bowl.



DF 5015 Boulevard Drinking Fountain

Perforated pedestal in mild steel or stainless steel.
Stainless steel bowl.



DF 5020 Wall Mounted Drinking Fountain

Stainless steel body and bowl mounted to wall.

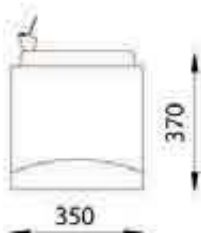

DF 5025 Brentford Drinking Fountain

Cast aluminium pedestal and base with stainless steel bowl.



DF 5030 Timber Slat Drinking Fountain

Steel framed with hardwood slats and stainless steel bowl.



DF 5055 Te Ari Drinking Fountain

Steel framed with hardwood slats and stainless steel bowl.

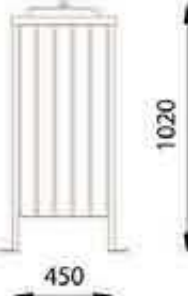

Select from our wide range of Planters or have Commercial Systems Australia custom manufacture to your specification to suit your individual requirements.



PB 1500
Stainless Steel Planter

Brushed or mirror polished body. Galvanised inner stainless steel liner.

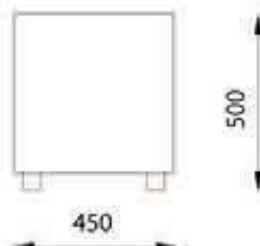

PB 1531
Perforated Planter

Perforated mild steel Planters with galvanised inner liners. Available in any size and configuration.

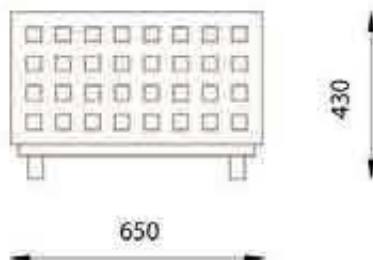

PB1540
Stainless Steel Cylindrical Planters

Brushed or mirror polished body with spun aluminium ring.

- PB 1540** 305 mm \varnothing x 410 mm high.
- PB 1541** 406 mm \varnothing x 410 mm high
- PB 1542** 457 mm \varnothing x 410 mm high
- PB 1543** 534 mm \varnothing x 410 mm high
- PB 1544** 610 mm \varnothing x 410 mm high
- PB 1545** 762 mm \varnothing x 410 mm high
- PB 1546** 235 mm \varnothing x 300 mm high
- PB 1547** 330 mm \varnothing x 400 mm high
- PB 1548** 450 mm \varnothing x 400 mm high

PB1560
Square Mild Steel Slat Planter

Powdercoated mild steel Planter with recessed base and adjustable feet. Galvanised inner liner.

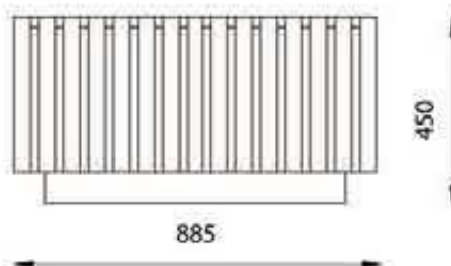



PB 1563
Rectangular Mild Steel Planter

Powdercoated mild steel slat Planter with legs and galvanised inner liner.

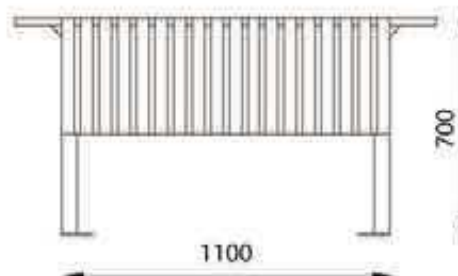

PB 1566
Steel Frame Timber Planter

Steel framed Planters with hardwood slats. Galvanised inner liner.

PB 1565 size 525mm x 525mm x 495mm high

PB 1566 size 685mm x 685mm x 605mm high.



PB 1567
Solid Vic Ash Planter

Available in Vic Ash (Internal use) or Jarrah (external use). Available with arched or straight top.

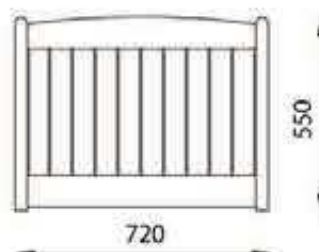

PB 1570
Solid Jarrah Planter

Available in Jarrah (external use) or Vic Ash (Internal use). Available with arched or straight top. Planter to compliment solid timber seats type TM 4150 and TM 4153.



Bollards to protect, direct and connect to the design elements of every streetscape project. Available as fixed, removable or hinged in a variety of colours and finishes.

SB 2002 Pyramid Top Bollard

Solid Jarrah or Cypress Pine. Signwritten if required. Optional inset collars, chain lugs and reflectors. Also available with dome top.

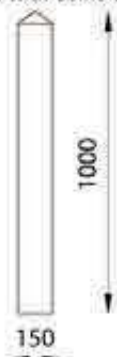

SB 2005 Standard Traffic Bollard

Steel capped or concrete filled. Optional chain lugs. Signwritten or reflective bands if required.

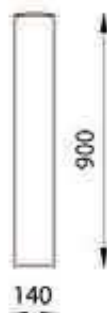

SB 2010 Cast Contemporary Bollard

Ornamental heritage style cast Bollard. Designed to compliment a range of sign poles, panels and light poles.



SB 2011 Cast Spiral Bollard

Ornamental cast Bollard. Designed to compliment a range of sign poles, light poles and sign panels.



SB 2012/13 Bridge Mall Bollard

Spun dome top with cast spiral base.

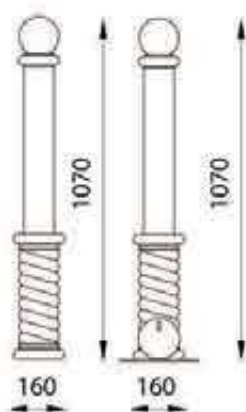

SB 2015 Standard Dome Top Bollard

Cast aluminium dome top Bollard with two collars. Cast dome top either polished aluminium or powdercoat finish. Shown as removable.

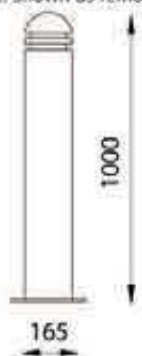

SB 2021
Chrome Bollard

Solid tubular pipe with chrome polish finish.

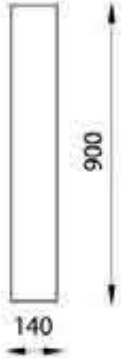

SB 2030
Foreshore Bollard

Solid Cypress Pine waisted Bollard. Routed collar with feature metal band.

SB 2031 Informal Bollard (rear of photo).

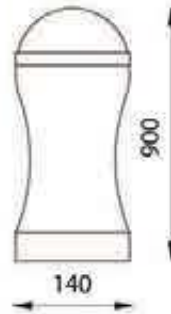

SB 2040
Melbourne Style Bollard

Fabricated mild steel Bollard. Optional spun stainless or mild steel dome top SB 2041. (refer page 45).

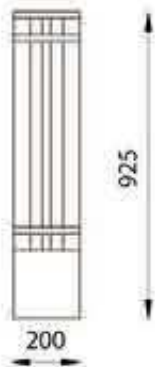

SB 2046
Cast Top Bollard

Cylindrical mild steel Bollard with cast aluminium top and base. (Shown as removable).

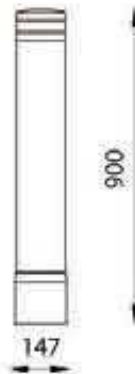

SB 2050
Olympics Bollard

Mild Steel cylindrical Bollard with stainless steel dome top.

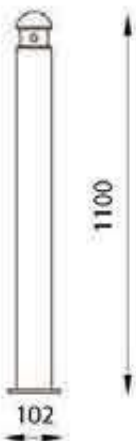

SB 2052
Plains Bollard

Stainless Steel cylindrical Bollard with flush welded top.



SB 2054 Removable Security Bollard

Stainless Steel cylindrical removable Bollard with spun stainless steel dome cap. Sub surface mounted sleeve. Key locked.



SB 2056 Stainless Steel Elliptical Bollard

Stainless steel pipe with angular elliptical top.



SB 2060 Brentford Bollard

Cast Bollard. Compliments a range of Directory Boards, Sign Poles and Drinking Fountain DF 5025.



SB 2065 Smokers Bollard

Stainless steel spring loaded smokers Bollard with stainless steel dome top. Key locked.



SB 2076 Triangular Bollard

Triangular steel tube Bollard with flat top. Also available with tapered top. Polished stainless steel finish.

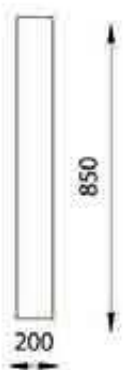

SB 2085 Glen Eira Bollard

Mild Steel RHS removable bollard with galvanised cap top.



Control foot traffic around shopping centres, schools, railway stations and park areas. Ask us how we can design barriers, fencing and café screens to suit your requirements.



BA 8000 Village Pedestrian Barrier

Tubular steel modular Barrier compliments the Village Bench TM 4195, Litter Receptacle LR 6136 and Tree Guard TG 1061.

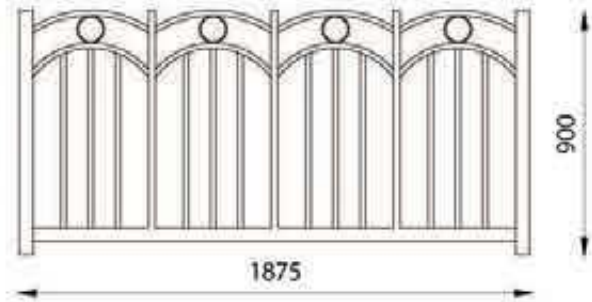

BA 8010 Circle Pedestrian Barrier

Tubular steel modular Barrier with SB 2015 Bollard Posts. Compliments Tree Guard TG 1051.

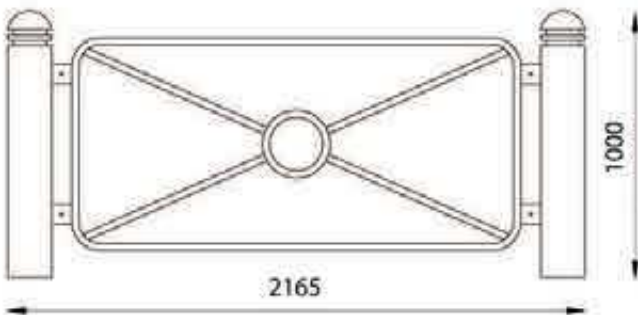

BA 8015 Barkly Style Barrier

Steel Barrier modules with SB 2041 Bollard Posts.

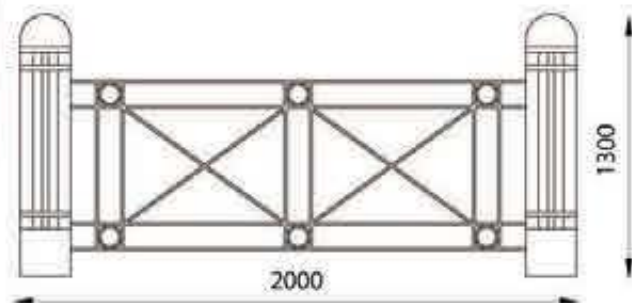



BA 8020.1
Standard Pedestrian Barriers

Standard tubular steel frames with looped mild steel tube.

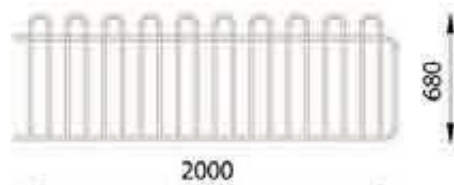

BA 8020.2
Cast End Pedestrian Barriers

Feature cast end posts with looped mild steel tube.

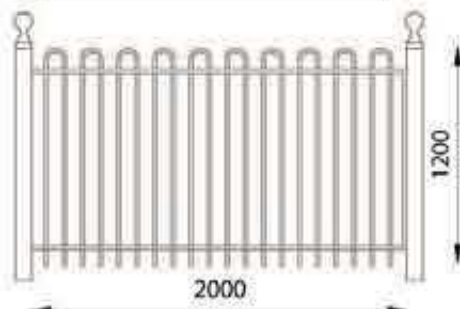

BA 8020.3
Capped Post Pedestrian Barriers

Capped posts with looped mild steel tube.

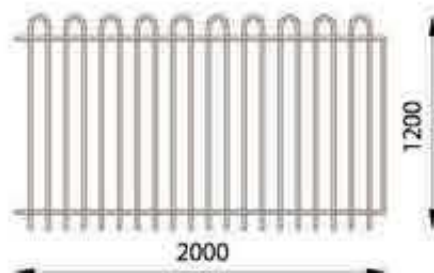

BA 8030
Café Barriers

Commercial Systems Australia standard polycanvas Café Barriers
Length 2000mm, Height 900mm.
Available as lace tied or slide on to tubular frames.

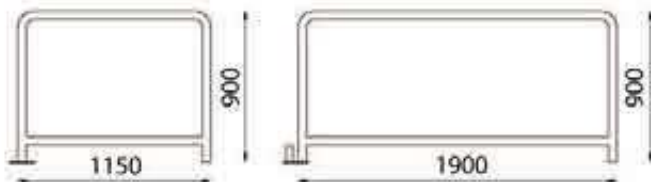

BA 8035
Glen Waverley

Wall style glazed panels for wind protection.

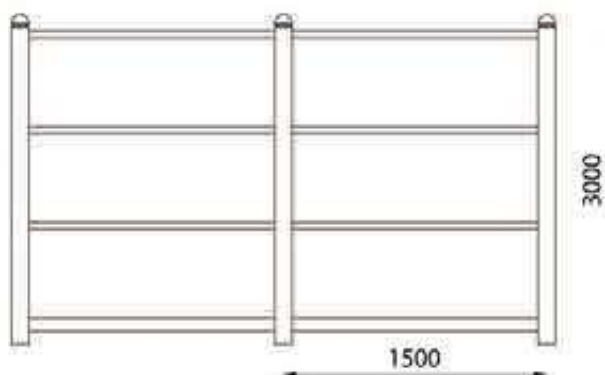



BA 8040
Bike Path Chevron

Galvanised mild steel pipe with inset directional sign.

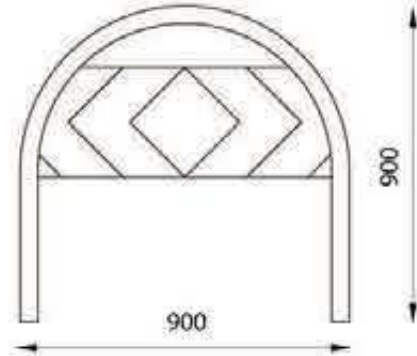

BA 8045
Carlton Fence

Laser cut steel plate fins provide a very different style of Barrier.

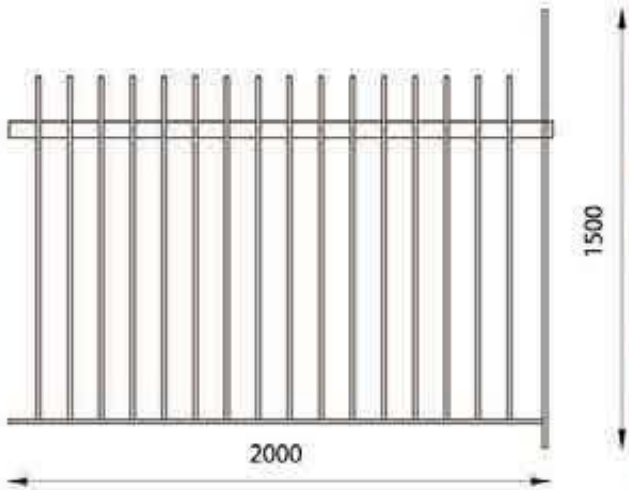

BA 8050
Transit 1 Style Glazed Screen

Feature post tops.
Wall style glazed panels providing wind protection.

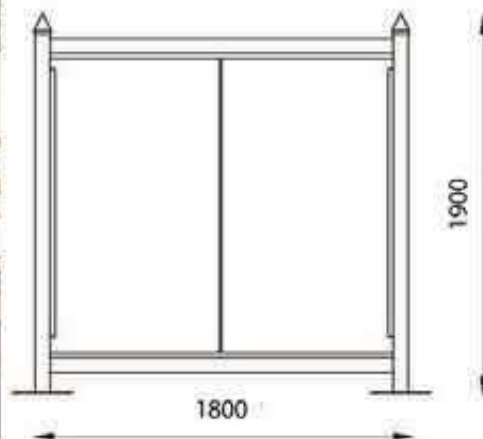



BA 8055
Transit 2 Style Screens

Mild steel RHS frame with flat posts and glazed panels.

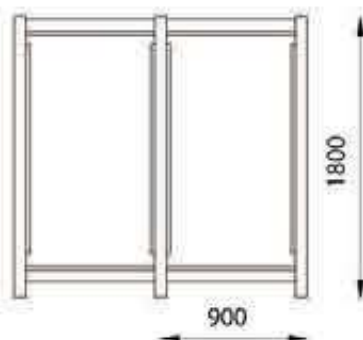

BA 8060
Glazed Café Barriers

Mild steel RHS frame with safety glazed panels.
Available with hinged end panels.

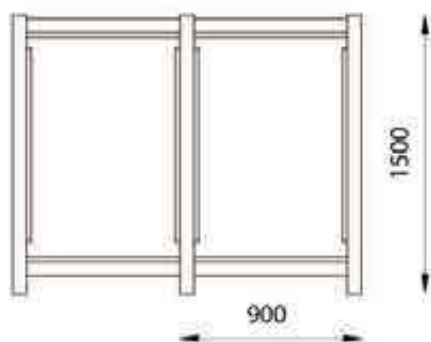

BA 8065
Custom Barrier

Custom design and manufactured stainless steel Pedestrian Barrier with precinct signage.

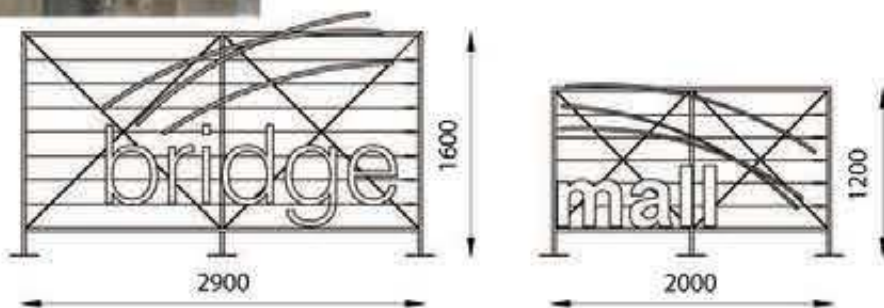

A range of Tree Guard designs are available to suit all situations. Tree Guards are supplied in two halves for easy installation. Optional bases for fixing to grates, ground frames or concrete.

TG 1005
Standard Tree Guard

Mild steel slat Tree Guard. Available with a straight, flared or rolled top.



TG 1007
Flared Top Tree Guard

Mild steel slat Tree Guard.

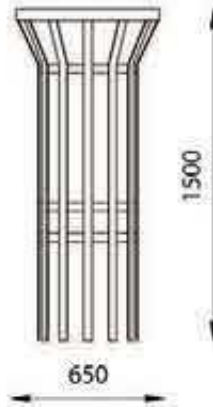

TG 1008
Plaza Tree Guard

Tapered mild steel fins with connecting tubular top and base.

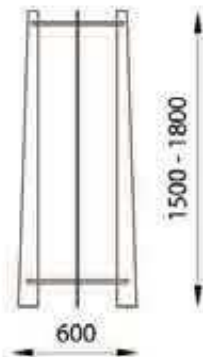

TG 1035
Olympic Village Tree Guard

Rolled vertical rods with connecting flat plate rings.



TG 1040
Victorian Tree Guard

Steel tube Tree Guard with choice of feature cast aluminium tops.



TG 1045
Bayside Tree Guard

Mild steel looped rod Tree Guard with flared base.

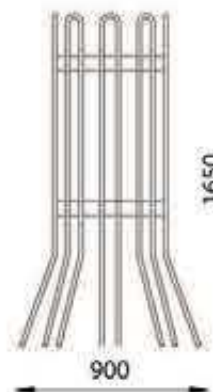

TG 1051
Frankston Tree Guard

Square Tree Guard in mild steel.

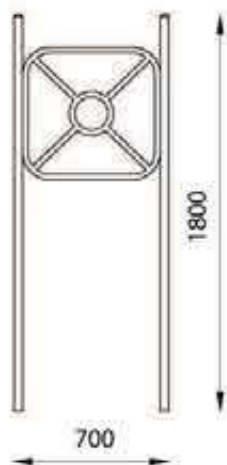

TG 1061
Xavier Tree Guard

Square Tree Guard in mild steel.

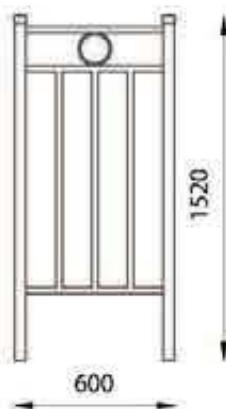

TG 1072
Looped Tree Guard

Mild steel looped rod Tree Guard.



TG 1070
Nouveau Tree Guard

Cast aluminium Nouveau design Tree Guard.



TG 1073
Armadale Tree Guard

Fem fatale design, mild steel rod Tree Guard.

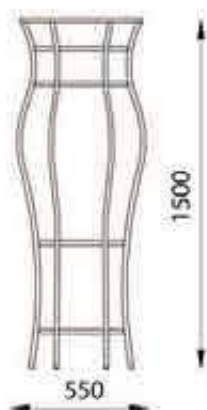

TG 1075
Metropol Tree Guard

Cast aluminium figure design tree guard.



Bus and Train Shelters, Gazebos and Shade Structures manufactured in a variety of styles, materials and colour combinations. A wide choice of seating available for the interiors of all shelters.



BS 8000 Classic Bus Shelter

Mild steel frame, toughened glass panels.
Shown with TM 4065 Seat.

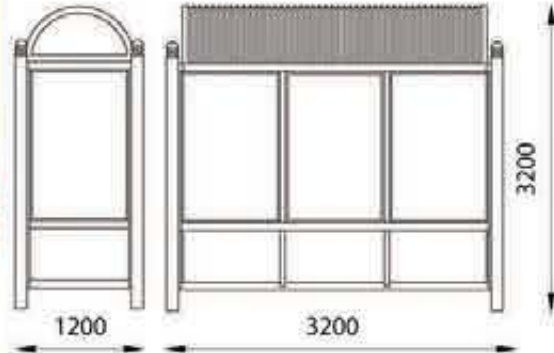

BS 8030 Coach Box

Mild steel frame with corrugated
Colorbond sheet.

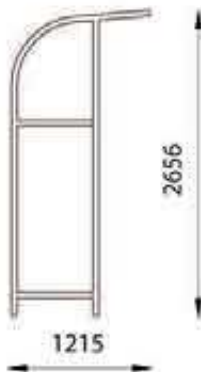

BS 8040 Circle Picnic Shelter

Rolled Colorbond roof with mild steel frame and
optional perforated metal infill. Versatile Shelter
ideal for picnic and transit areas.
Shown with BA 8055 Screens.

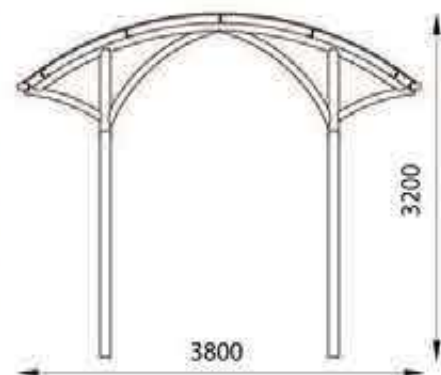



BS 8045
Security Shelter

Mild steel frame, Colorbond arch roof with feature laser cut panels and safety glass or perspex windows. Lockable Security Shelter.



BS 8050
Olympics Bus Shelter

Modular Transit Shelter. Mild steel pipe frame, Colorbond arch roof and safety glass or perspex windows. Concealed drainage. Shown with optional seat TM 4156.

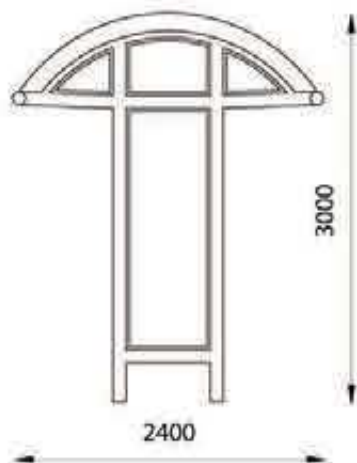

BS 8055
Colac Bus Shelter

Steel Shelter with laminated safety glass panels and Colorbond roof. Shown with optional bench TM4053.





BS 8060
Extended Modular Transit Shelter

Stainless steel centre columns and mild steel roof frames. Colorbond arched roof. Shown with optional seat HM 3020 and steel frame glazed interlocking windbreaks BA 8050.

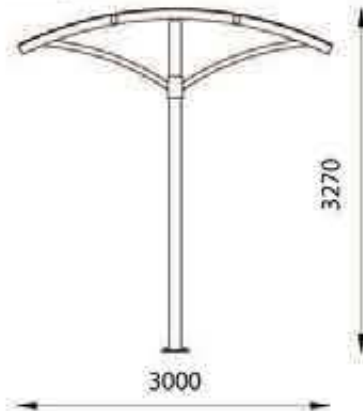

BS 8062
Frankston Shelter

Available with leaning rail or seats. Shown with Bin Enclosure LR 6158 SSF, Pedestrian Barrier BA 8010 and Bollard SB 2015.

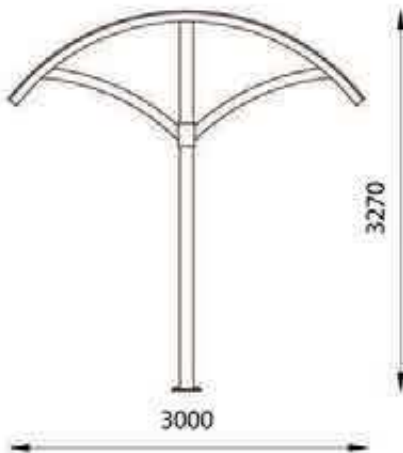

BS 8063
Epping Shelter

Mild steel frame, Colorbond flat roof and safety glass or perspex infills. Available with leaning rail or seats.

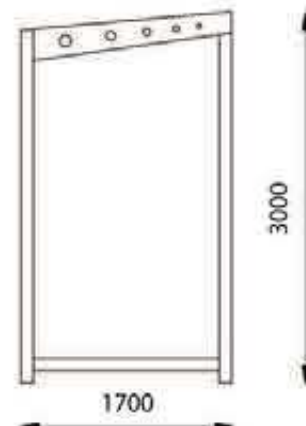



BS 8065
Met Shelter

Mild steel frame and Colorbond arched roof. Comes with leaning rail as standard. Optional Directory Board infill.



BS 8070
Marina Security Entrance Shelter

Galvanised mild steel frame and corrugated roof with weatherboard timbers. Wire mesh security gates.

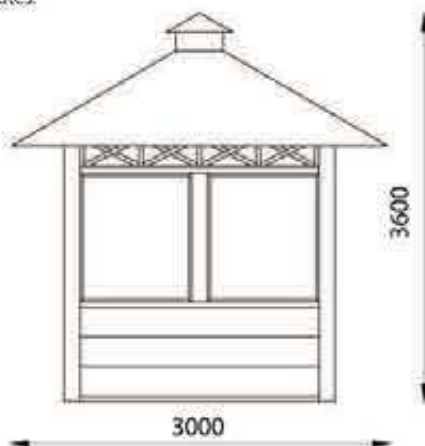

BS 8085
Nunawading Shelter

Mild steel frame, Colorbond flat roof with powdercoated mild steel sheet and perspex panel infills. Available with optional seats or benches.

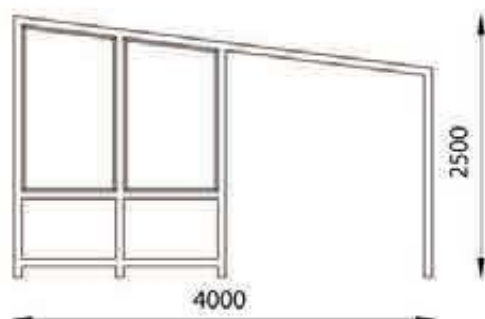



BS 8090
Woolongong Shelter

Mild steel frame with perforated back panels and optional side advertising notice board. Arched Colorbond roof. Perforated bench as standard.

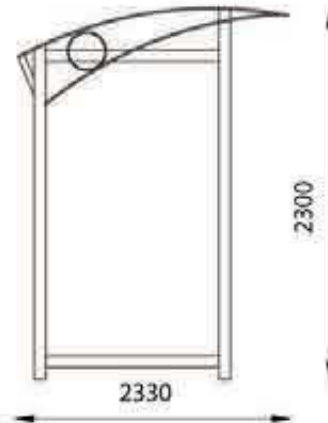

BS 8100
Vine Flat Roof Shelter

Mild steel frame, Colorbond flat roof with expanded metal infills. Available with seats or benches.



BS 8120
Bourke Arched Roof Shelter

Mild steel frame with feature cast posts and powdercoated mild steel sheet panels. Colorbond arched roof. Available with optional side wind protection panels and seating.

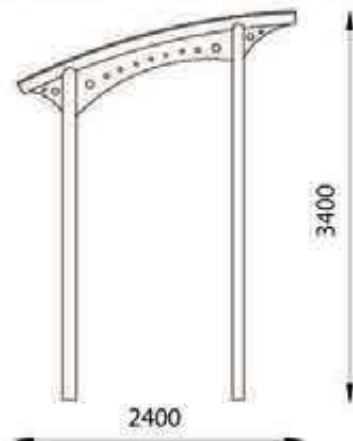



BS 8125
Heritage Dome Roof Shelter

Mild steel frame with feature cast posts and powdercoated mild steel sheet and perspex panels. Colorbond arched roof. Also available with optional front wind protection panels and seating



BS 8130
Mitchell Pitched Roof

Mild steel frame, Colorbond pitched roof with expanded metal infills. Shown with optional seat TM 4054.



BS 8131
Yarra Valley Shelter

Mild steel frame with arched Colorbond roof and perspex panels. Available in extended length. Versatile shelter ideal for outdoor tennis or sporting venues.

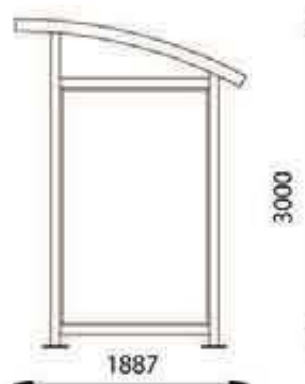

Directory and Notice Boards designed for Streets and Parks. Boards include gas struts to hinged doors, security locks, UV resistant Perspex panels and internal Front Runner fabric lining for Velcro attachment of notices.



DB 9006
Ashburton
Directory Board

Tubular steel arched frame with metal sheet infill for sign writing.

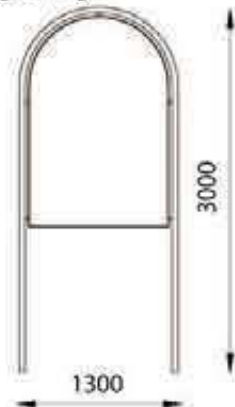

DB 9020
Town Square
Directory Board

Tubular post frame with cast end caps. Toughened glass or perspex lockable Directory Board.

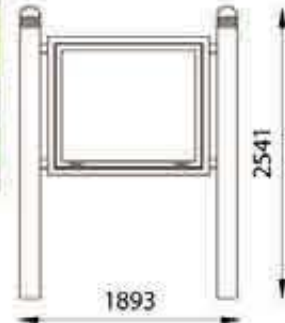

DB 9023
Montrose
Directory Board

Corporate double sided sign board in curved aluminium.



DB 9025
Glen Eira Directory
Board

Square tube frame with end caps. Toughened glass or perspex lockable Directory Board.

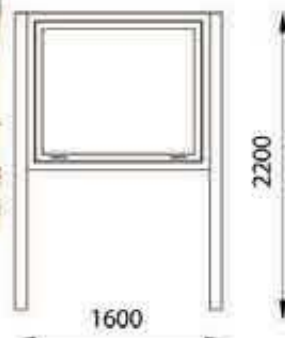

DB 9026
Guliwinki
Directory Board

Square tube frame with end caps. Toughened glass or perspex lockable Directory Board.

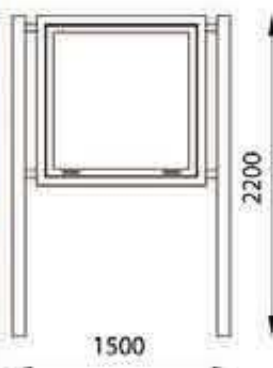

DB 9030
Hotham Directory
Board and Shelter

Mild steel tubular frame with rolled corrugated iron roof. Toughened glass or perspex lockable Directory Board with optional brochure holder.

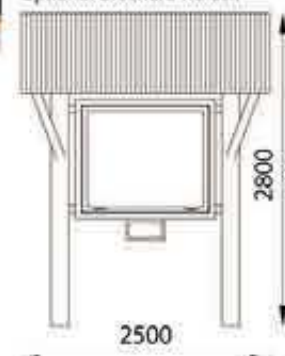

DB 9065 Bush Directory Board

Optional timber slat roof or corrugated iron roof. Toughened glass or perspex lockable Directory Board.



DB 9070 Deer Park Directory Board

Round tube frame with feature cap posts. Laser cut precinct name panel with perspex lockable Directory Board.

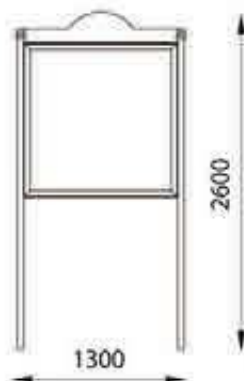

DB 9080 Park Directory Board

Mild steel frame with pitched corrugated Colorbond roof. Perspex lockable Directory Board.

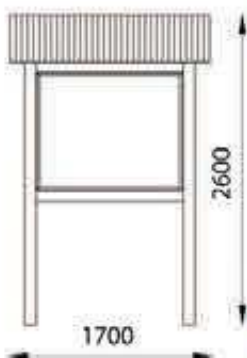

DB 9095 Frankston Directory Board

Toughened glass or perspex lockable Directory Board with metal frame. Manufactured to fit any size.

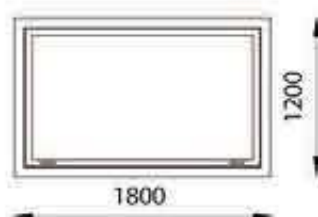

SS 9000 Street Sign

Cast aluminium sign blades ideal as a retailer directory. Clamp fixed to 90mm pipe.

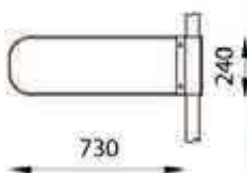

SS 9001 Brentford Sign Pole

Steel feature sign pole with sign panel.



Whether it's streetscapes, developing new housing estates, refurbishing strip shopping centres or new transit stations, **Commercial Systems Australia** can help to custom design and manufacture public furniture to suit your needs.

Our team of experienced qualified designers and manufacturers will ensure your furniture not only fulfills your custom project needs, but meets all Australian design and manufacturing standards. We source the highest quality materials and finishes and manufacture all products at our modern factory premises in Croydon, Victoria.

With over 20 years experience, we can help to achieve that unique look and feel, ensuring the end product will stand the test of time.



Project Sierra Estate, Cranbourne North Victoria
 Landscape Contractor Warrandale Industries
 Landscape Architect MDG Landscape Architects
 Developer Stockland



Project University Hill, Bundoora Victoria
 Landscape Contractor Raglan Meadows
 Architect Hassell Pty. Ltd.
 Developer MAB



Project Meadowglen Reserve Regional Skate Park
 Landscape Architects ACLA in association with Convic Skate Parks
 Client Whittlesea Council



Commercial Systems Australia Pty. Ltd.

Head Office

49-51 Vinter Avenue, Croydon 3136 Vic Australia

Phone (03) 9725 9344 Fax (03) 9725 9744

Email admin@commercialsystems.com.au Website www.commercialsystems.com.au

